

Perfis

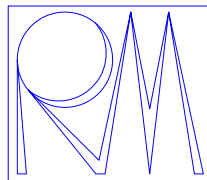

PVC Plastificado

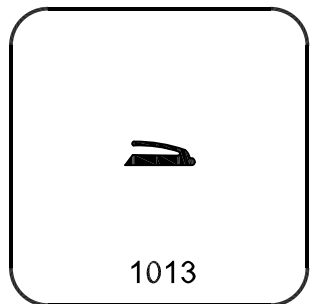

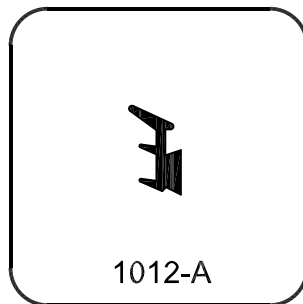
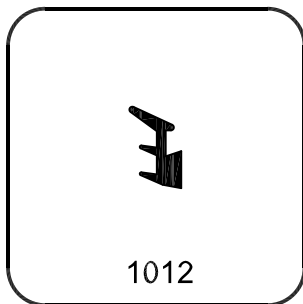
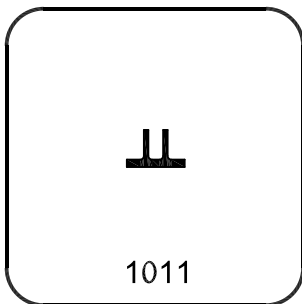
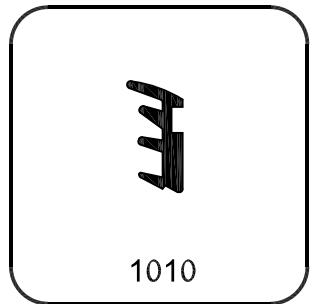
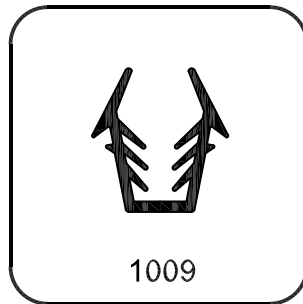
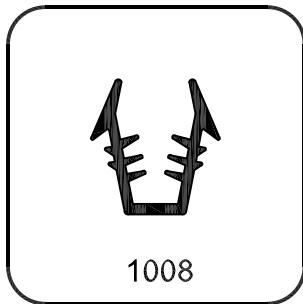
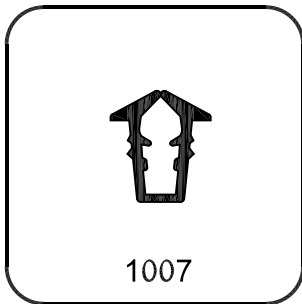
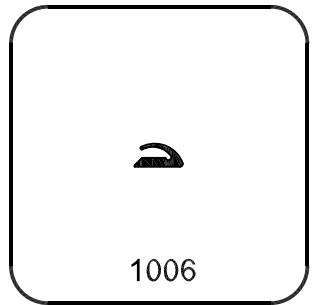
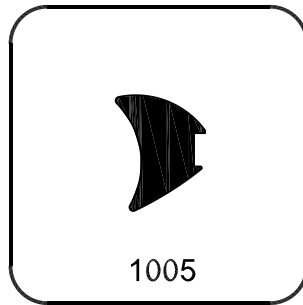
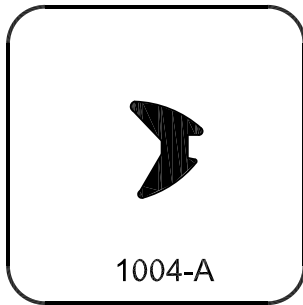
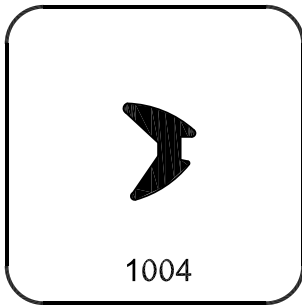
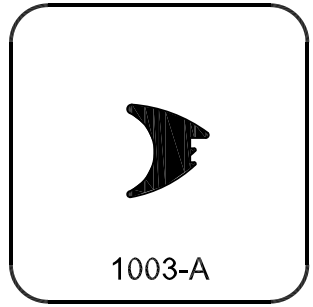
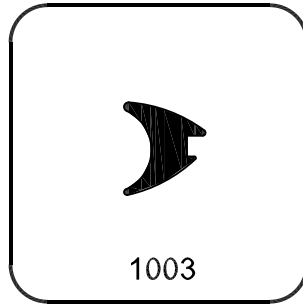
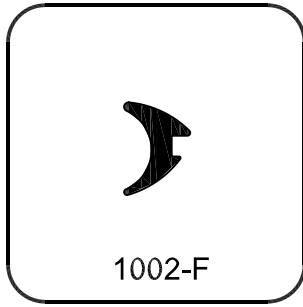
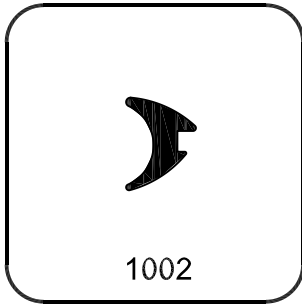
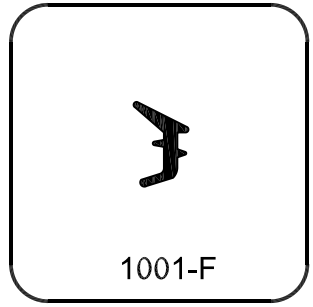
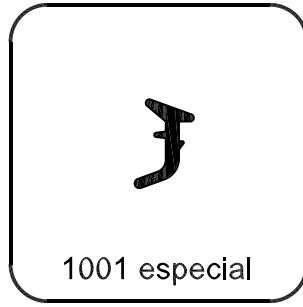
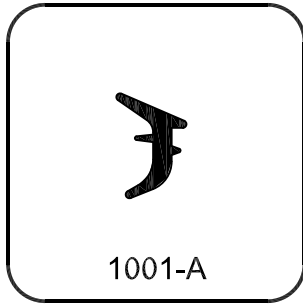
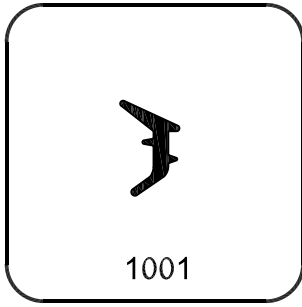

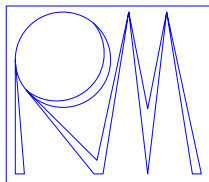
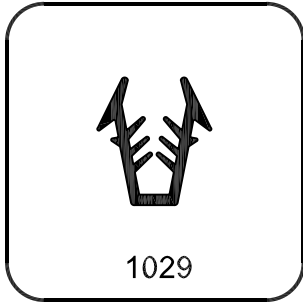
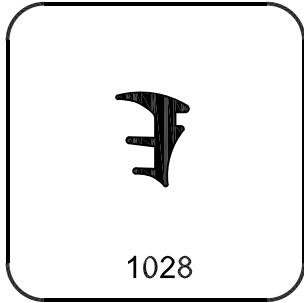
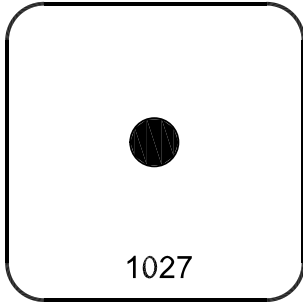
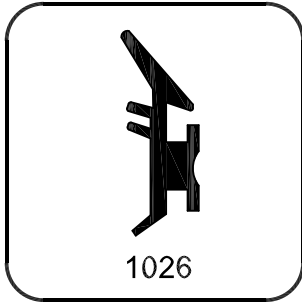
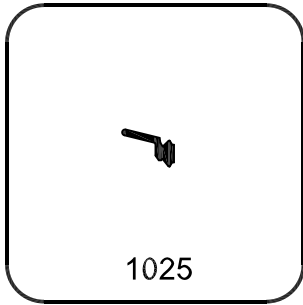
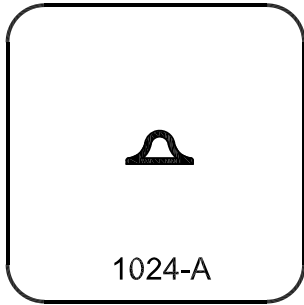
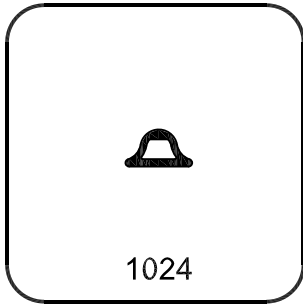
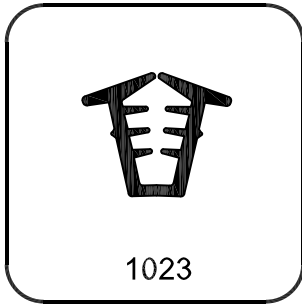
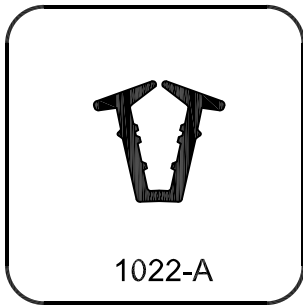
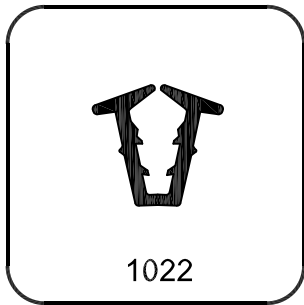
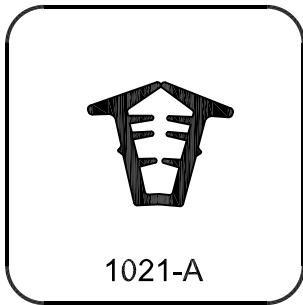
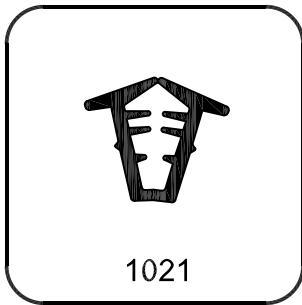
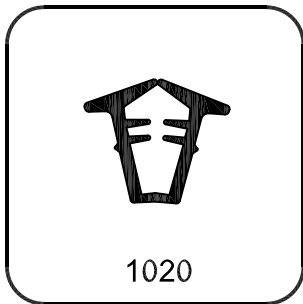
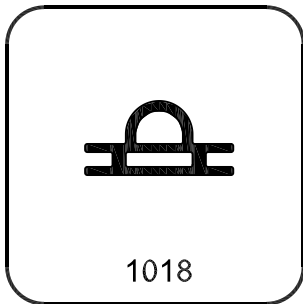
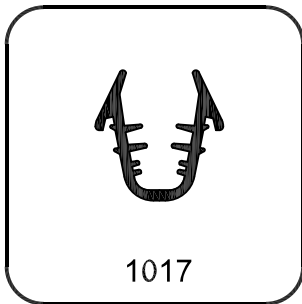
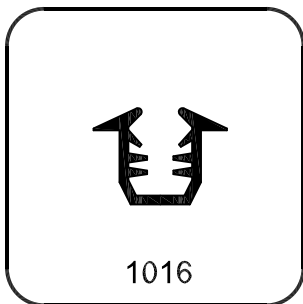
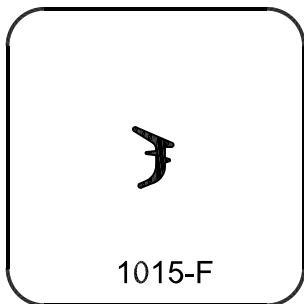
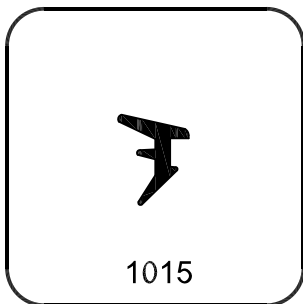
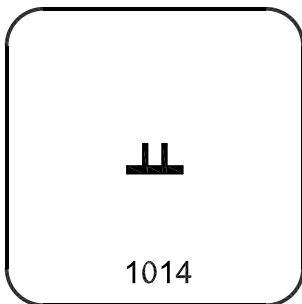

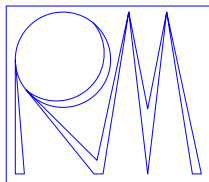
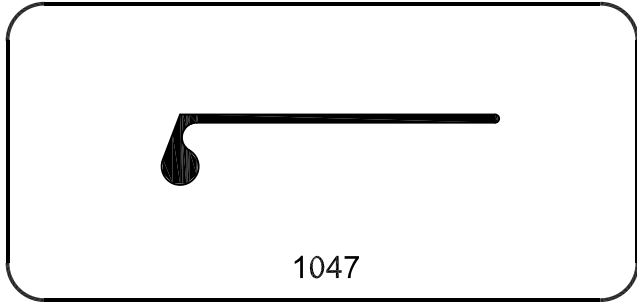
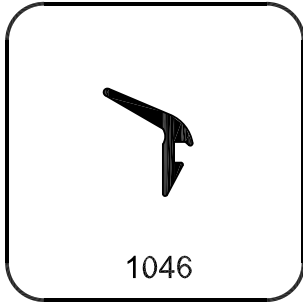
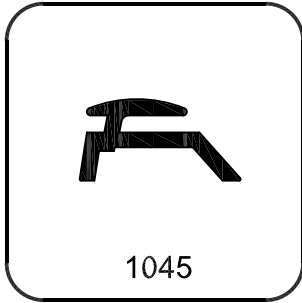
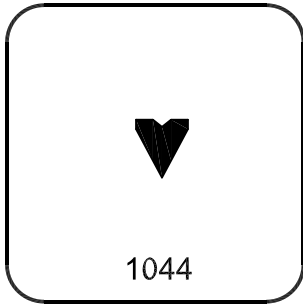
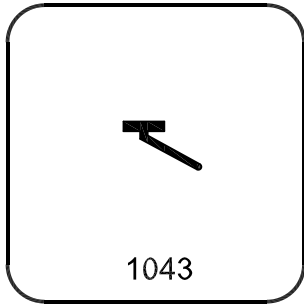
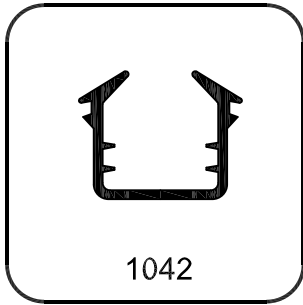
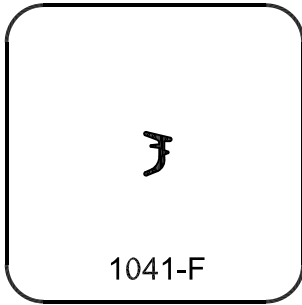
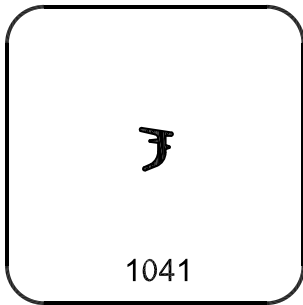
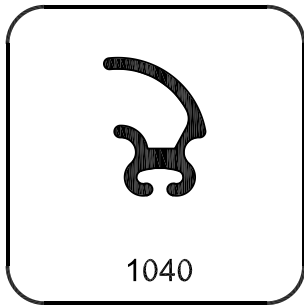
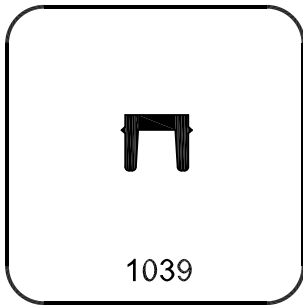
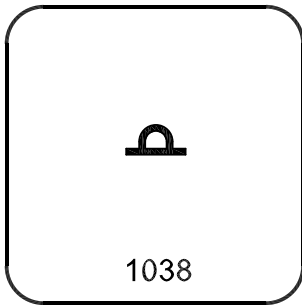
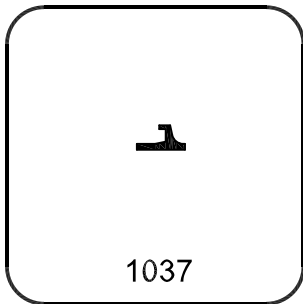
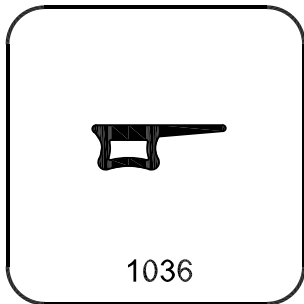
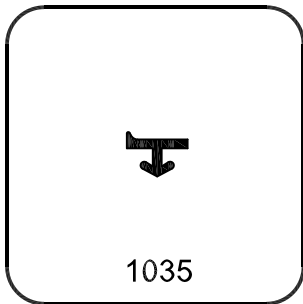
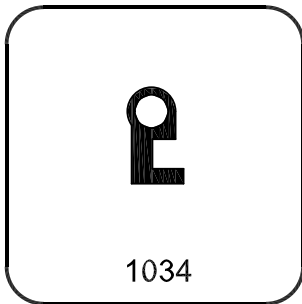
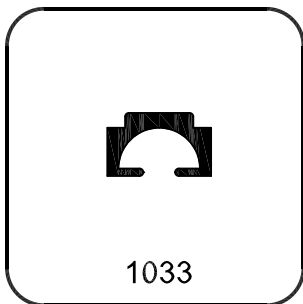
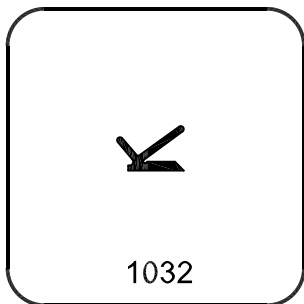
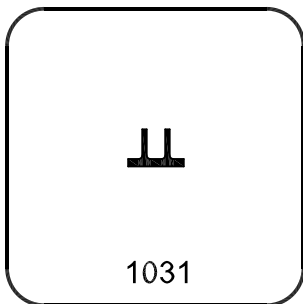
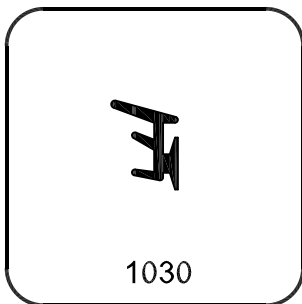

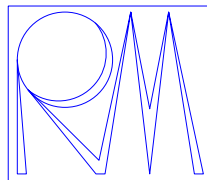
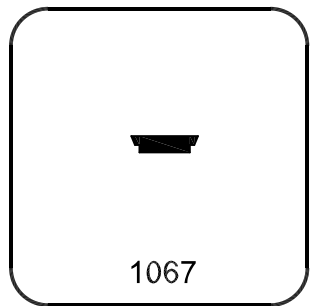
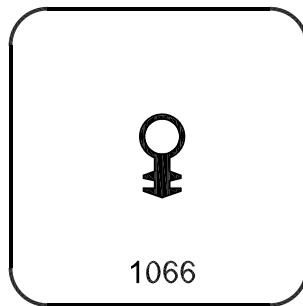
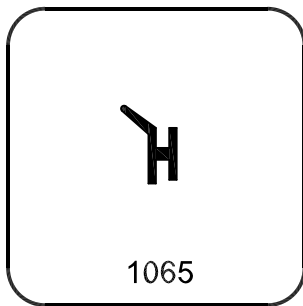
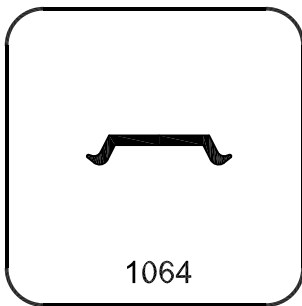
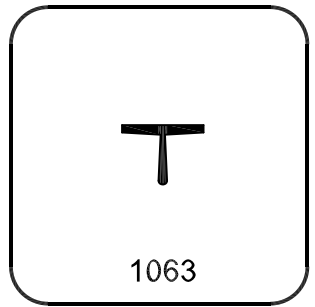
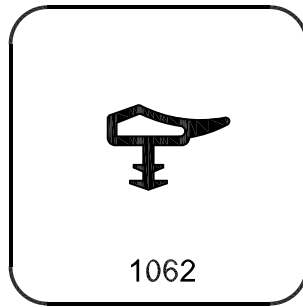
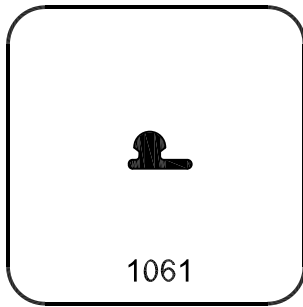
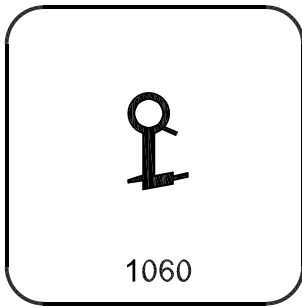
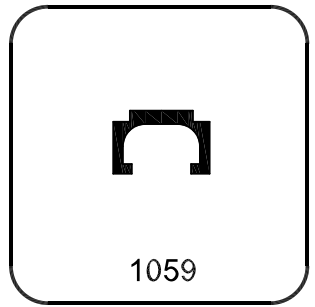
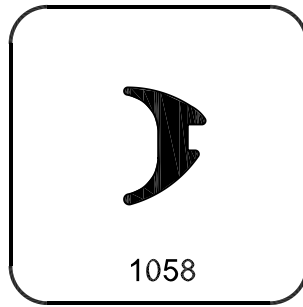
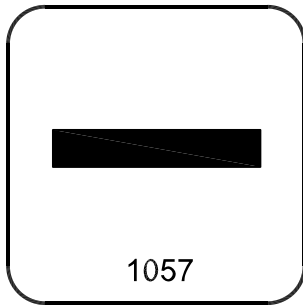
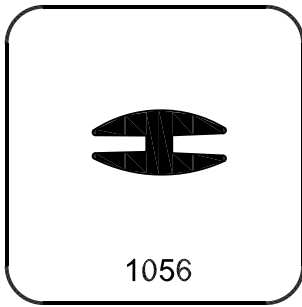
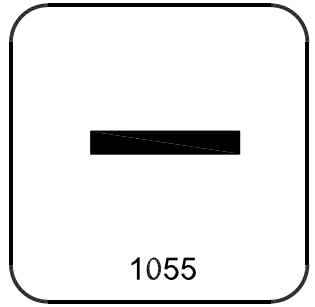
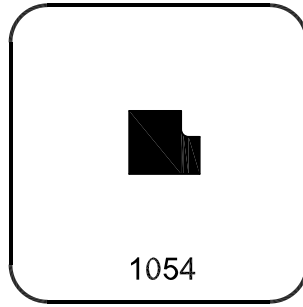
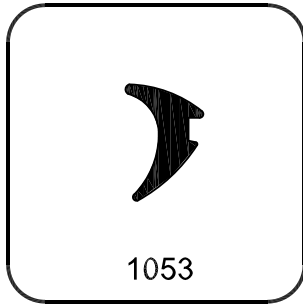
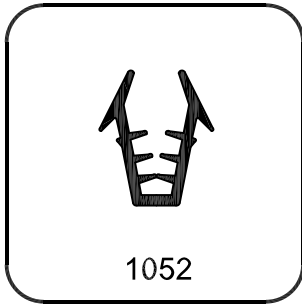
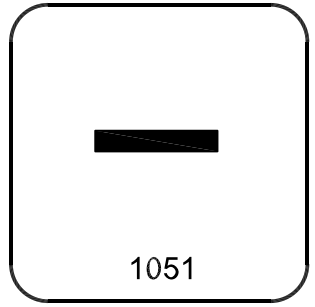
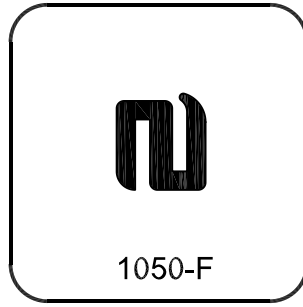
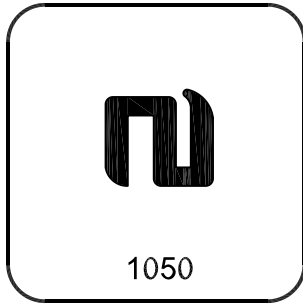
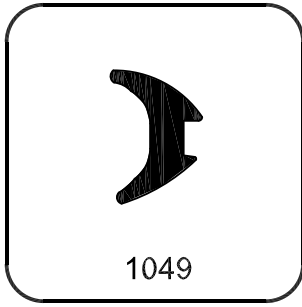

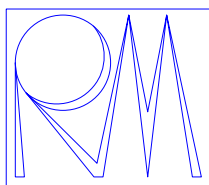
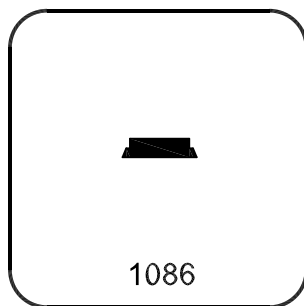
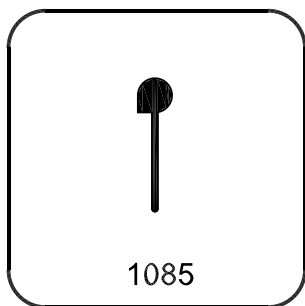
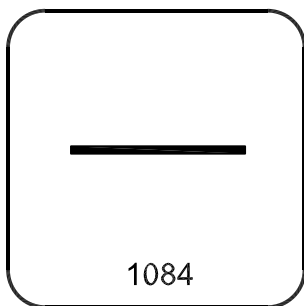
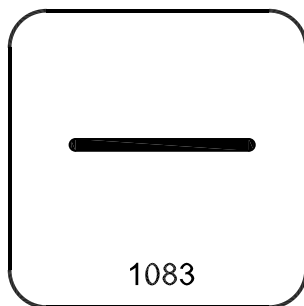
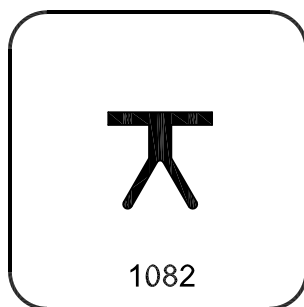
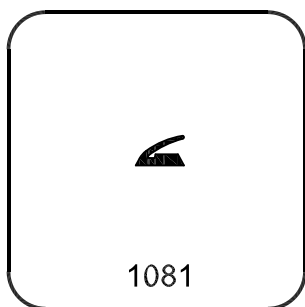
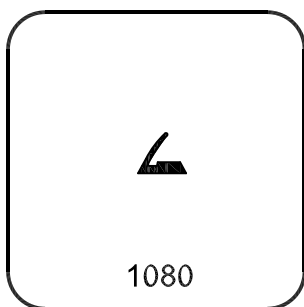
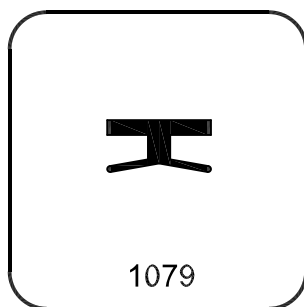
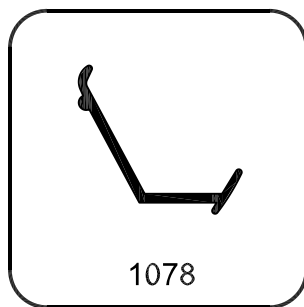
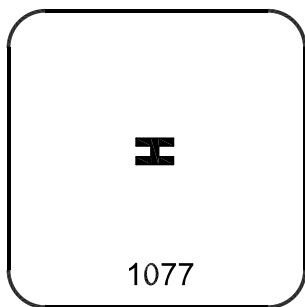
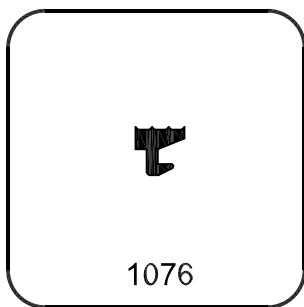
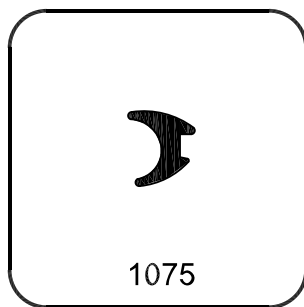
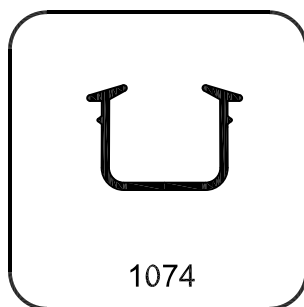
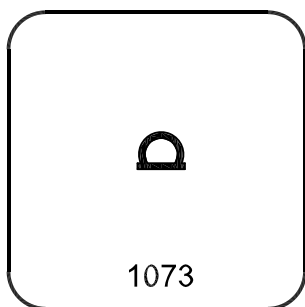
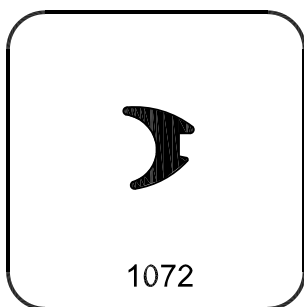
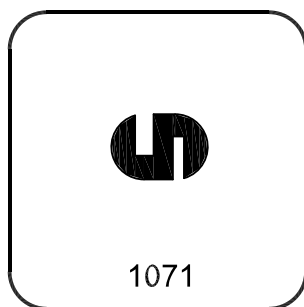
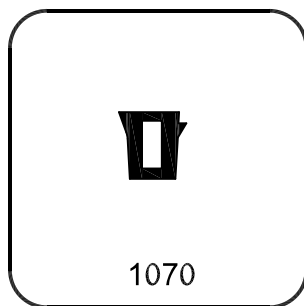
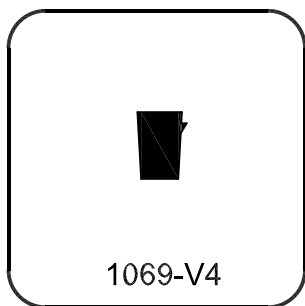
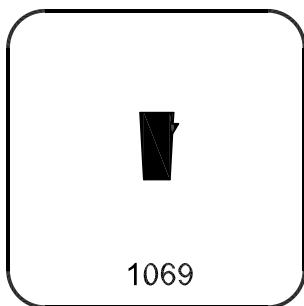
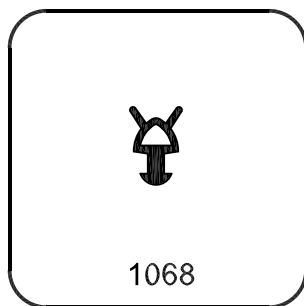

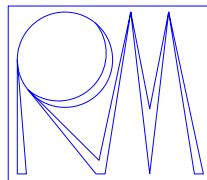
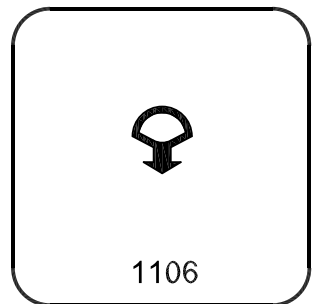
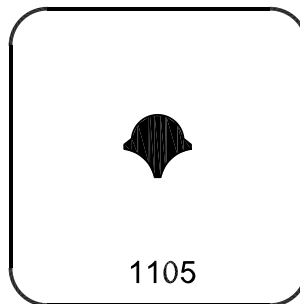
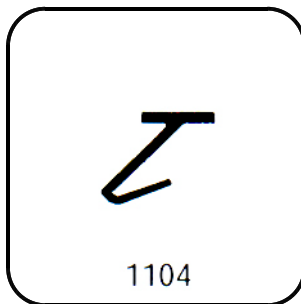
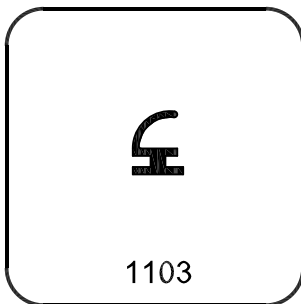
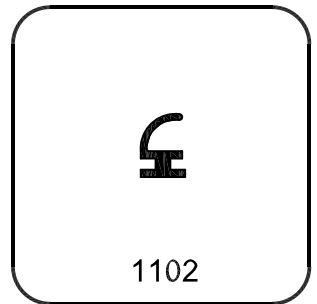
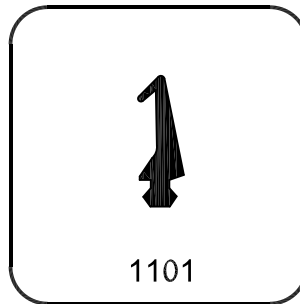
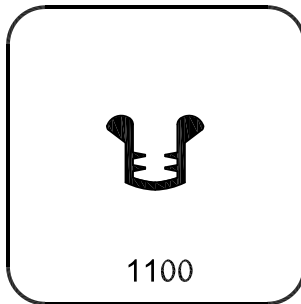
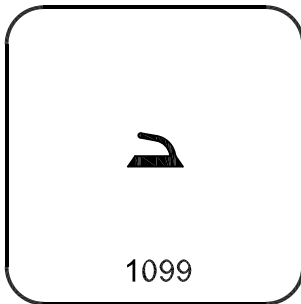
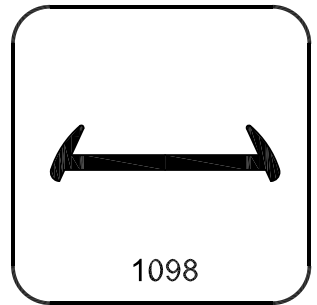
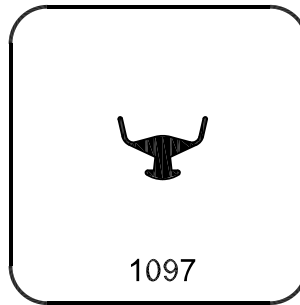
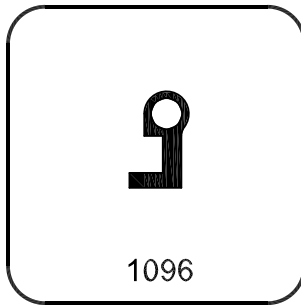
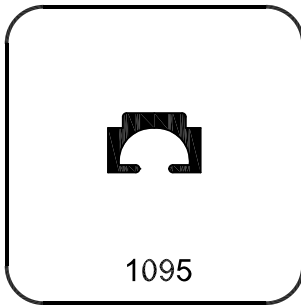
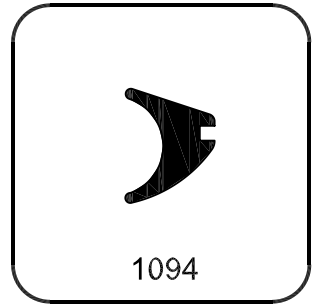
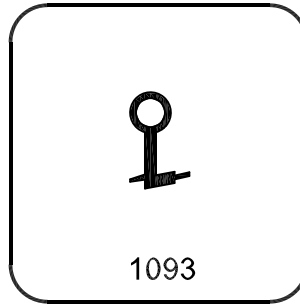
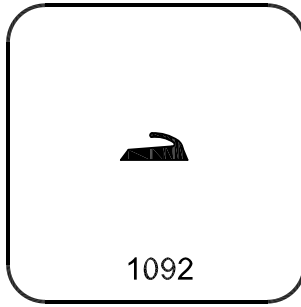
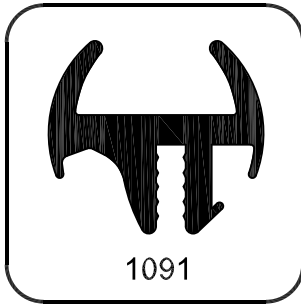
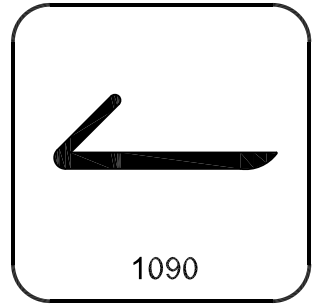
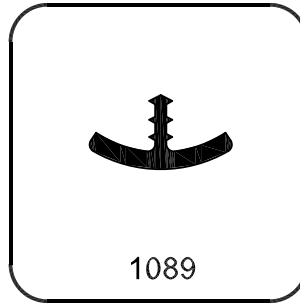
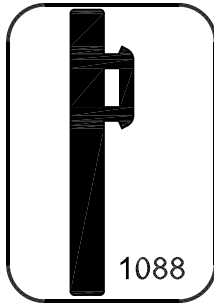
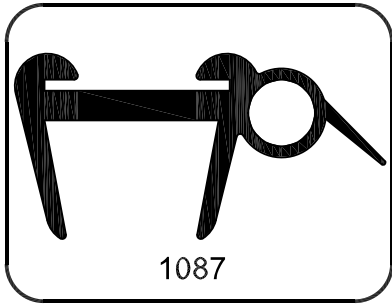

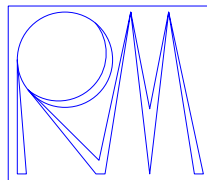
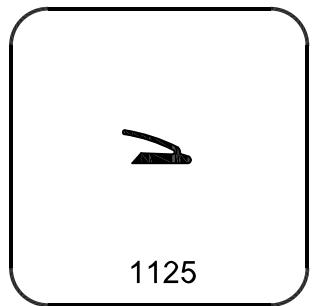
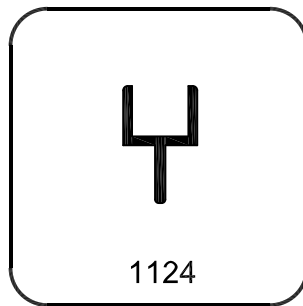
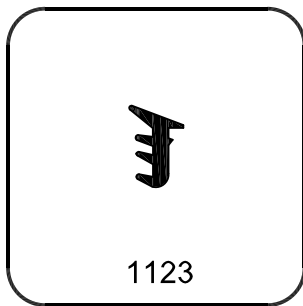
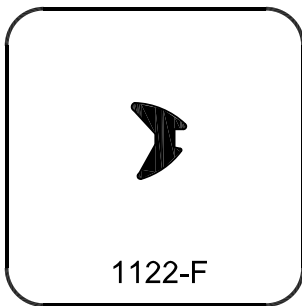
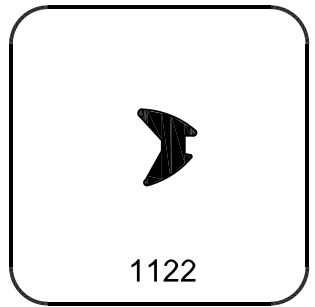
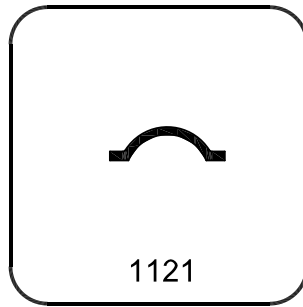
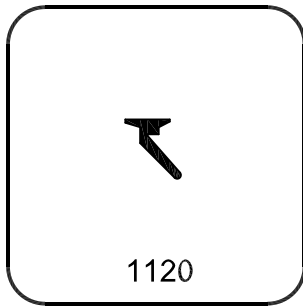
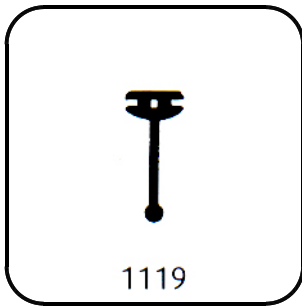
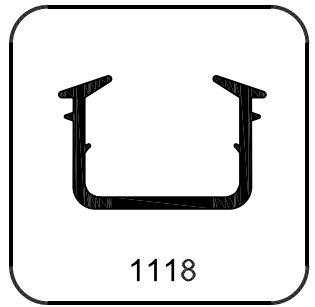
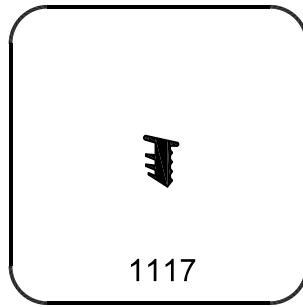
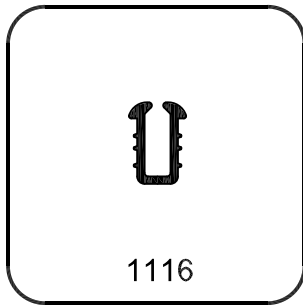
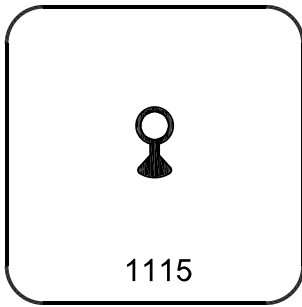
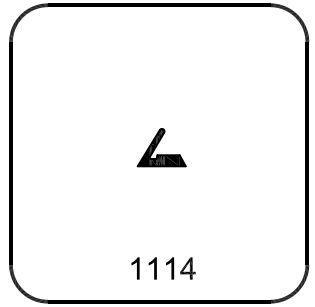
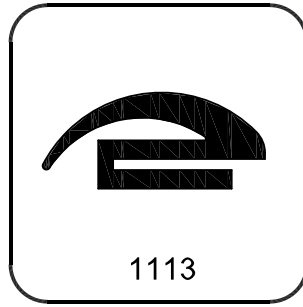
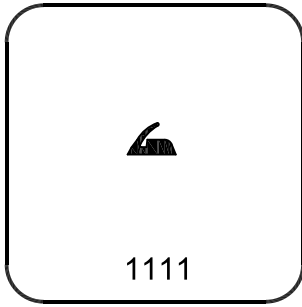
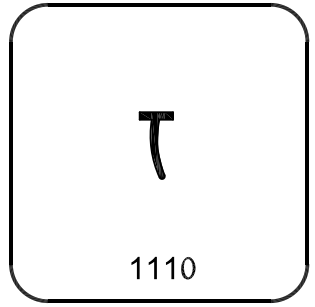
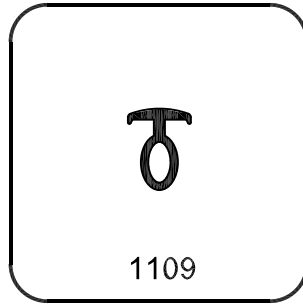
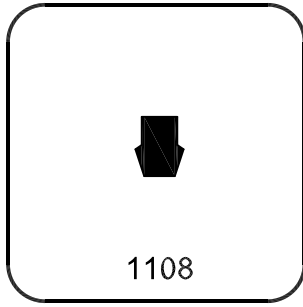
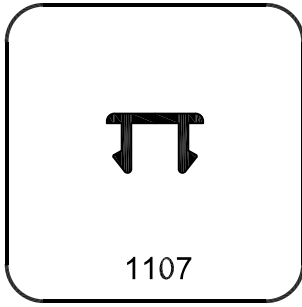

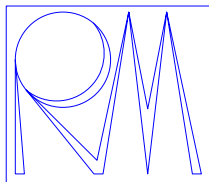
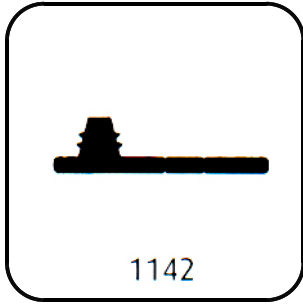
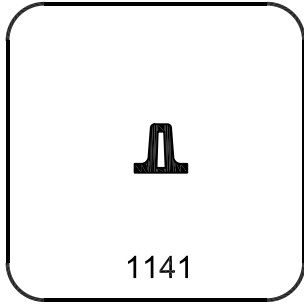
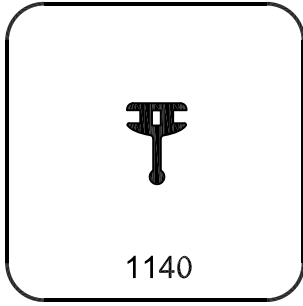
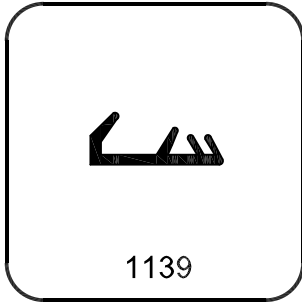
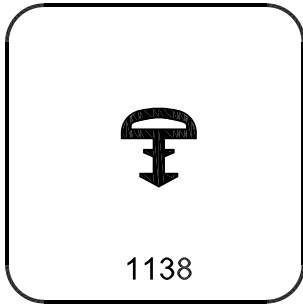
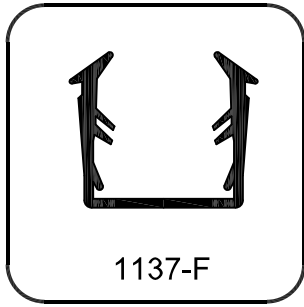
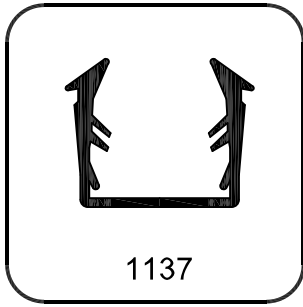
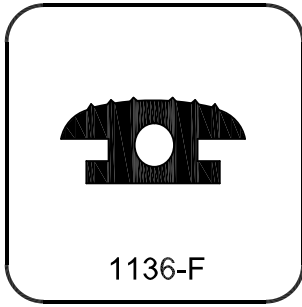
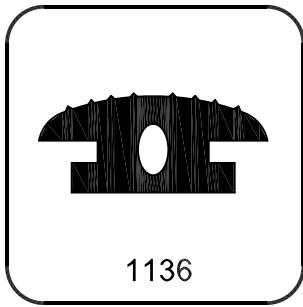
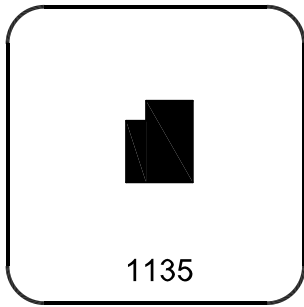
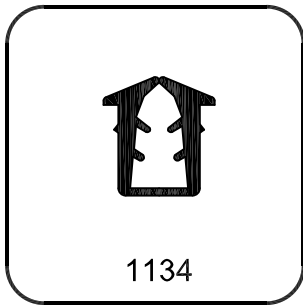
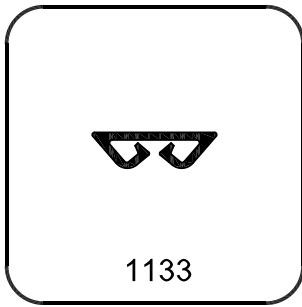
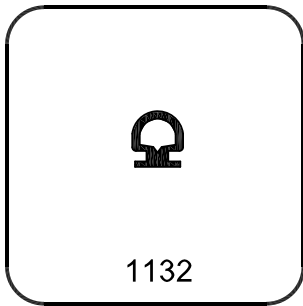
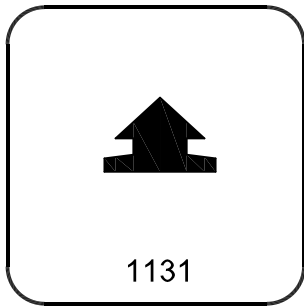
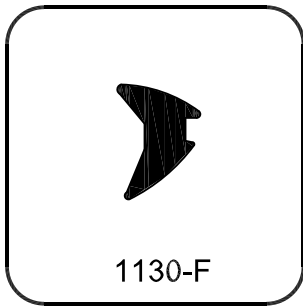
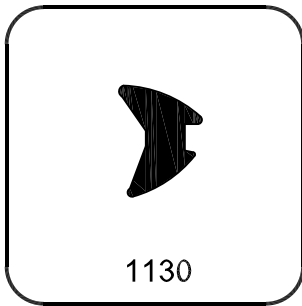
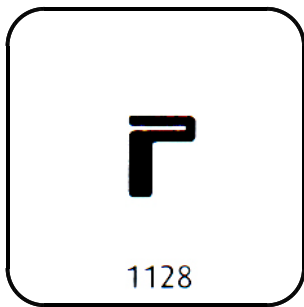
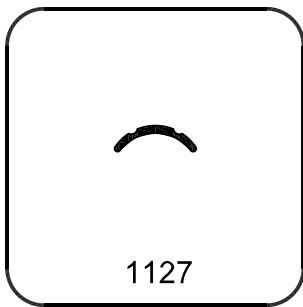
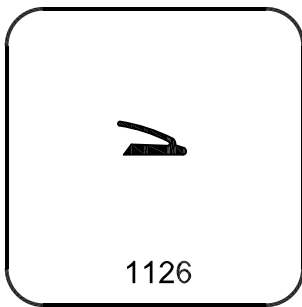

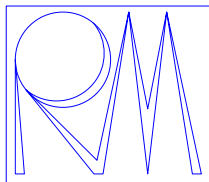
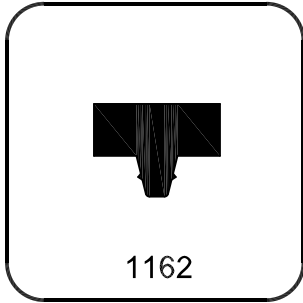
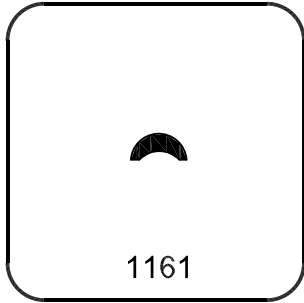
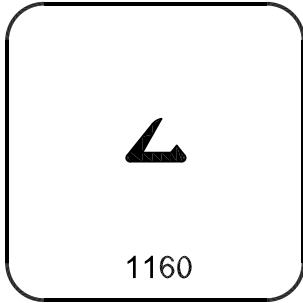
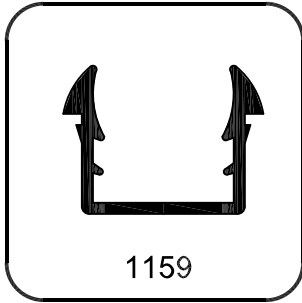
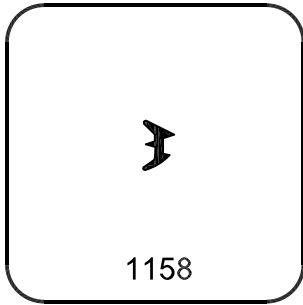
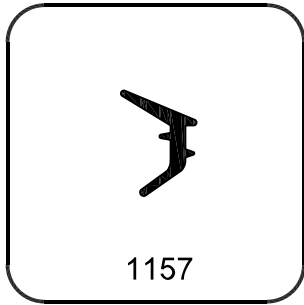
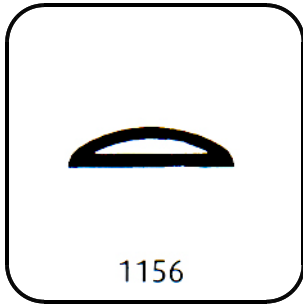
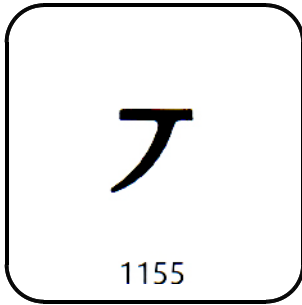
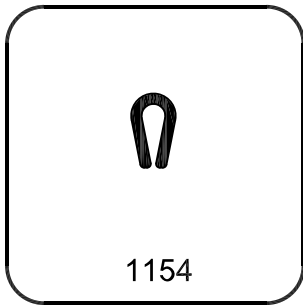
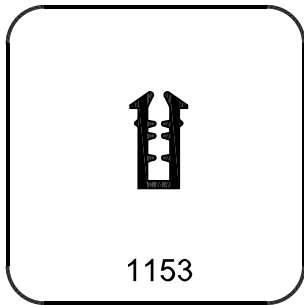
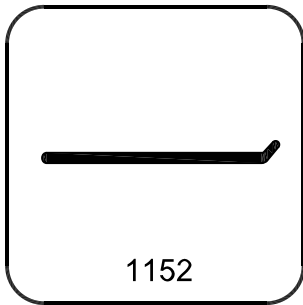
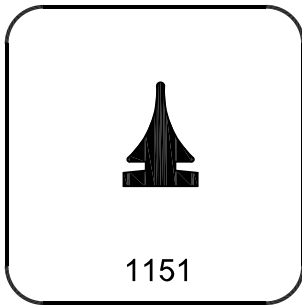
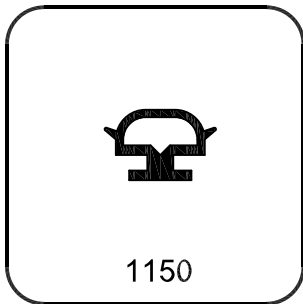
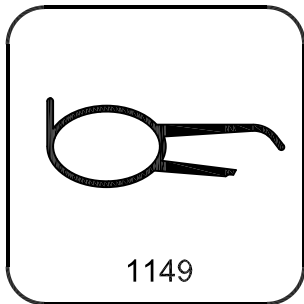
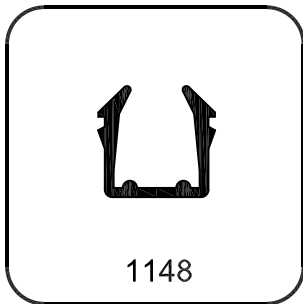
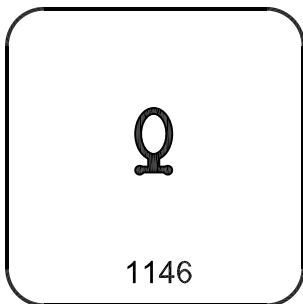
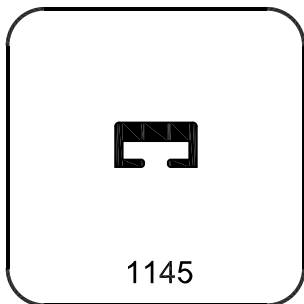
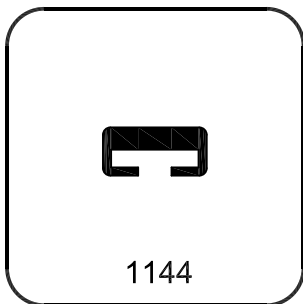
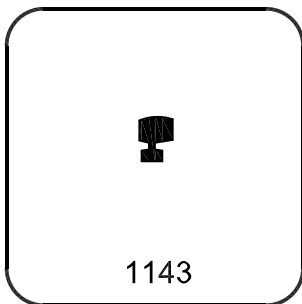

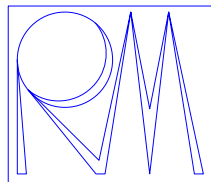
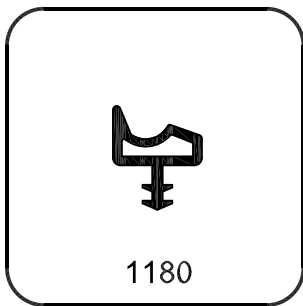
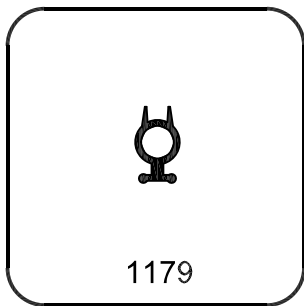
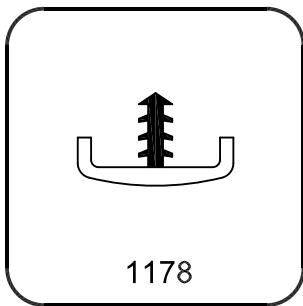
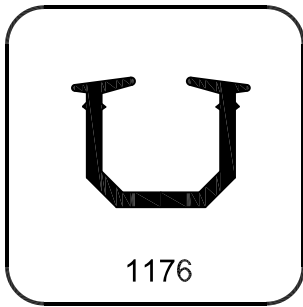
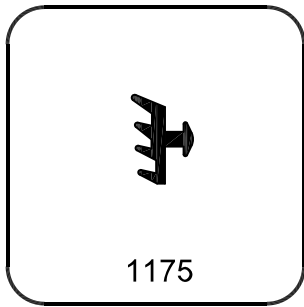
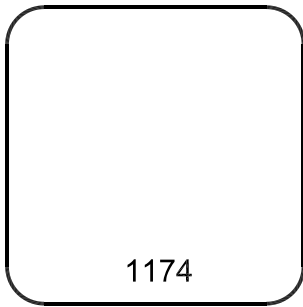
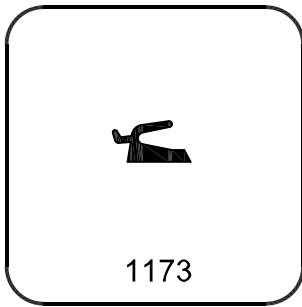
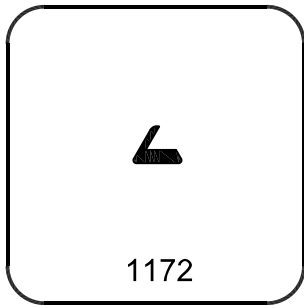
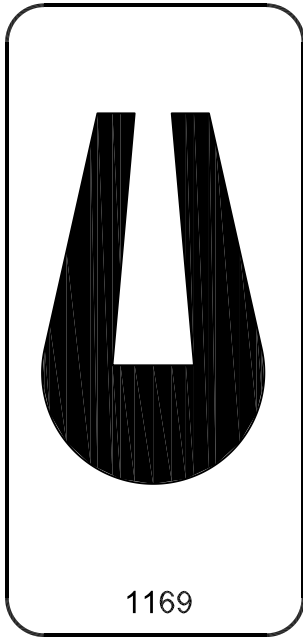
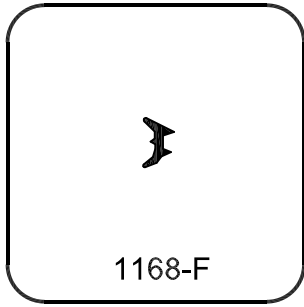
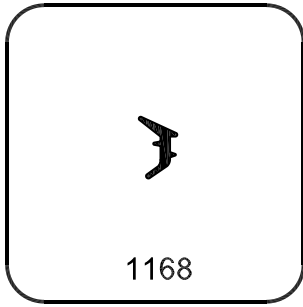
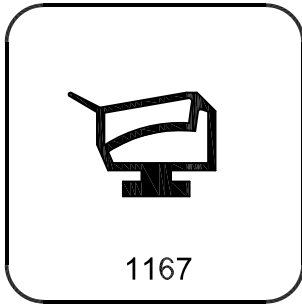
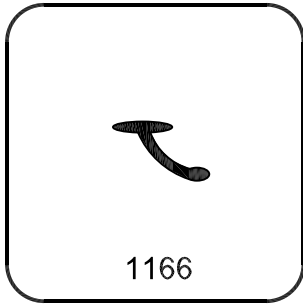
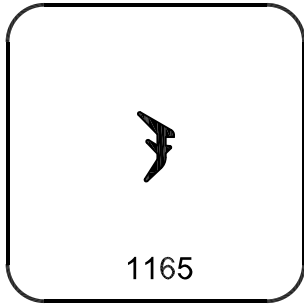
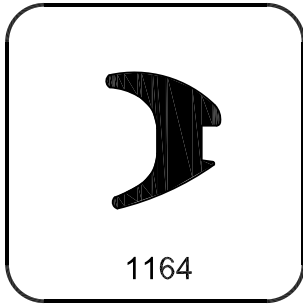
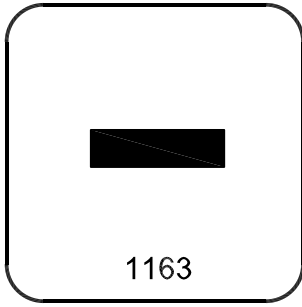

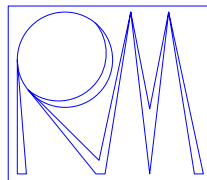
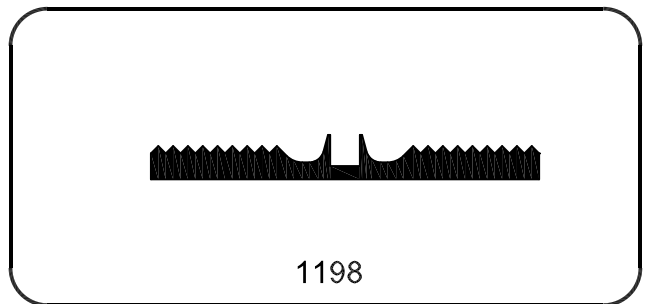
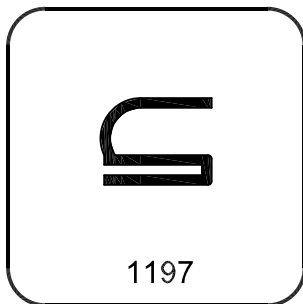
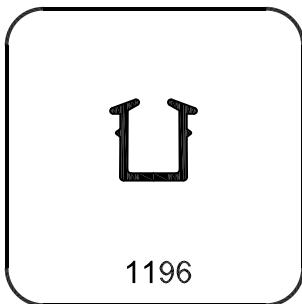
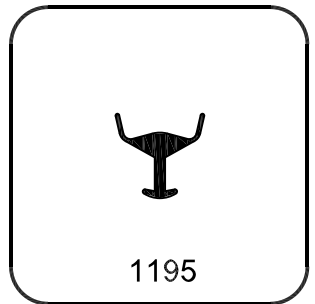
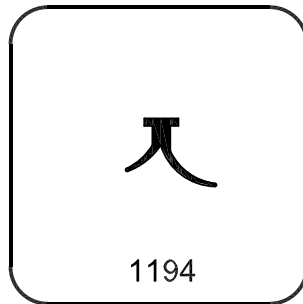
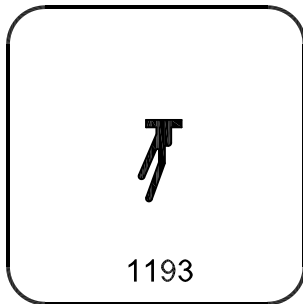
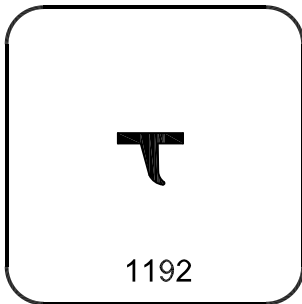
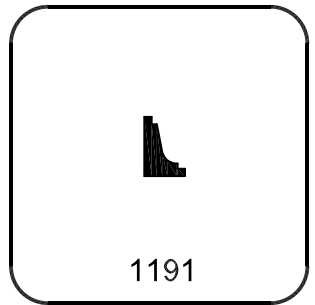
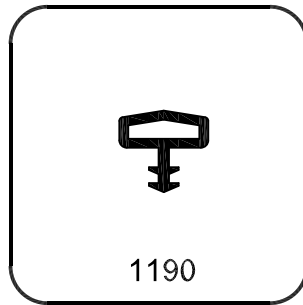
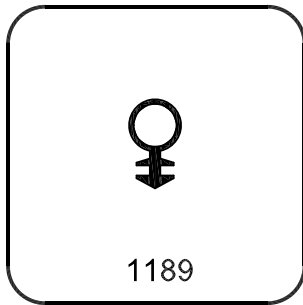
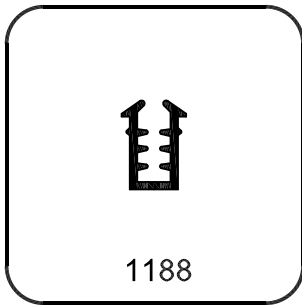
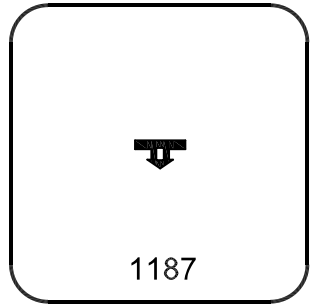
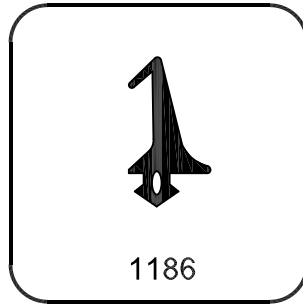
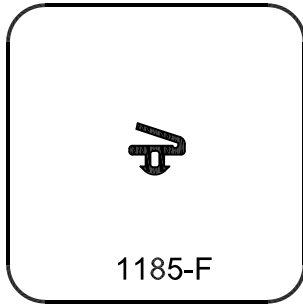
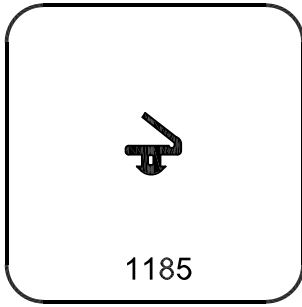
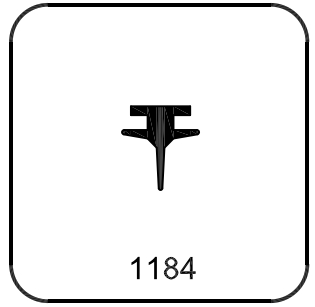
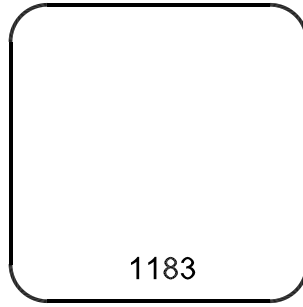
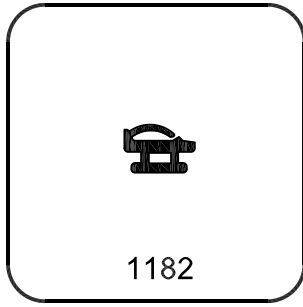
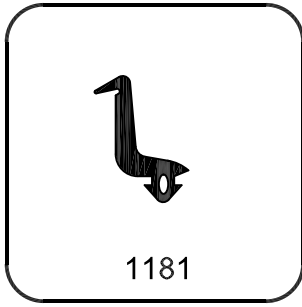

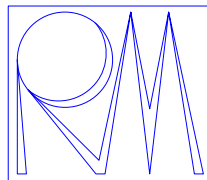
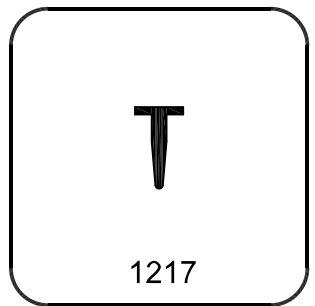
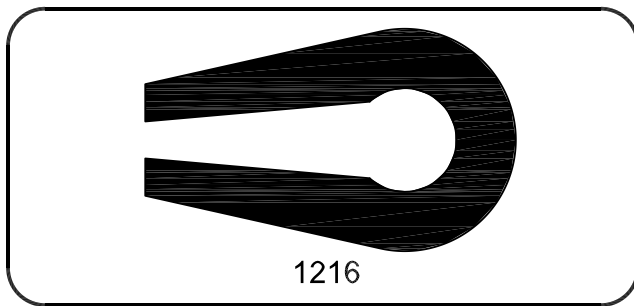
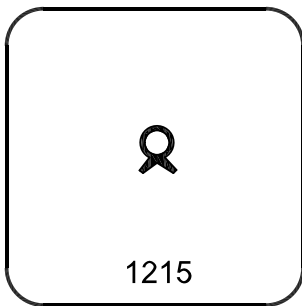
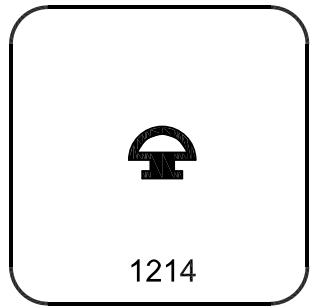
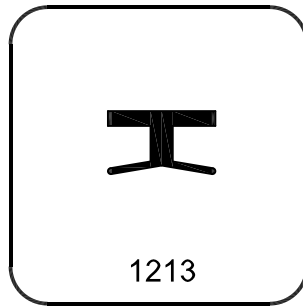
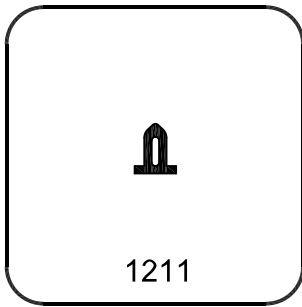
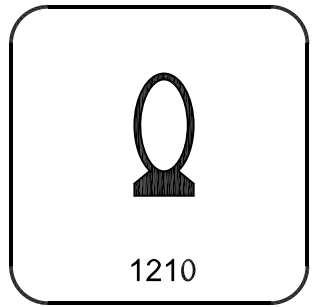
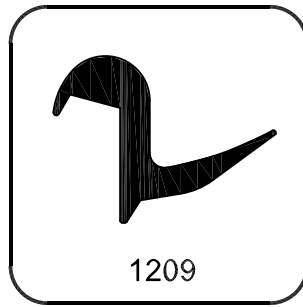
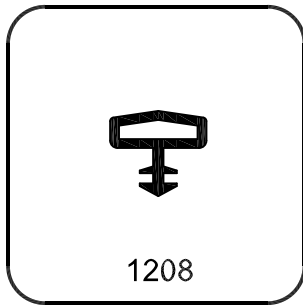
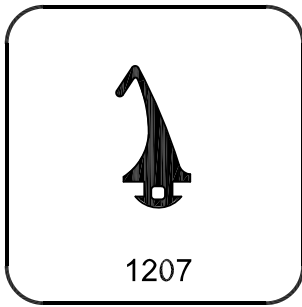
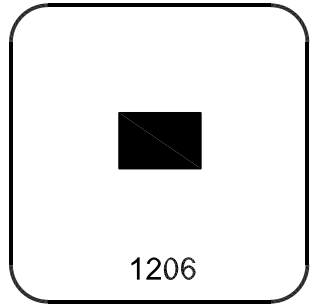
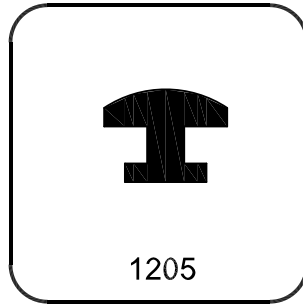
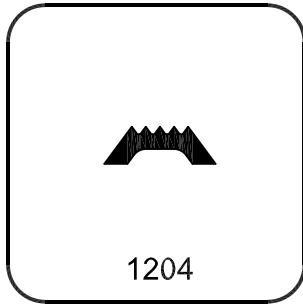
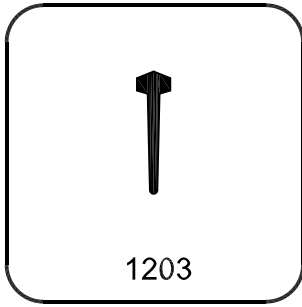
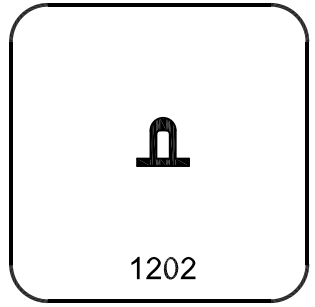
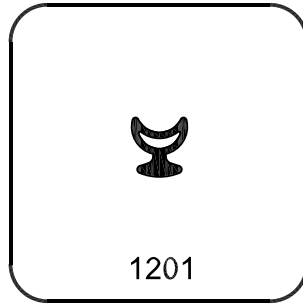
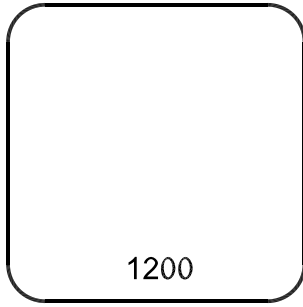
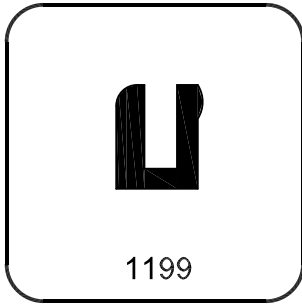

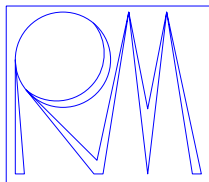
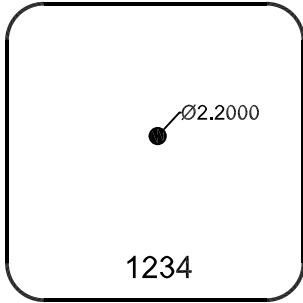
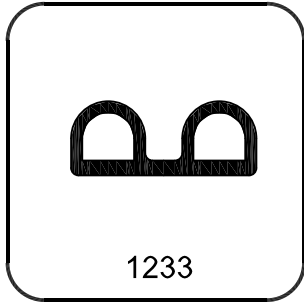
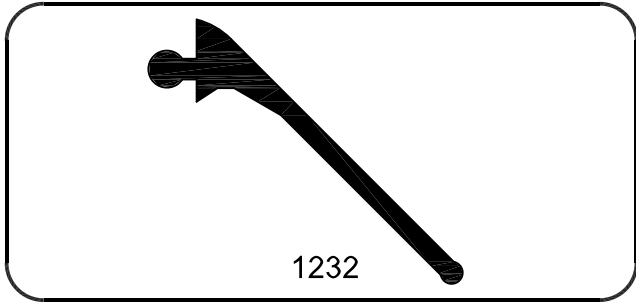
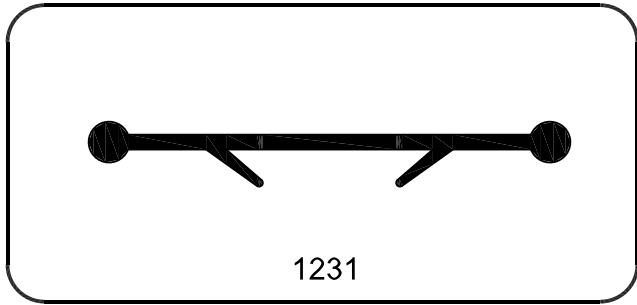
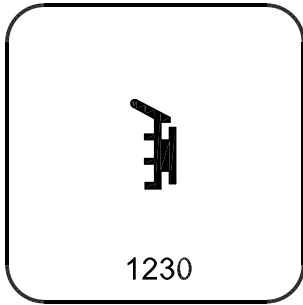
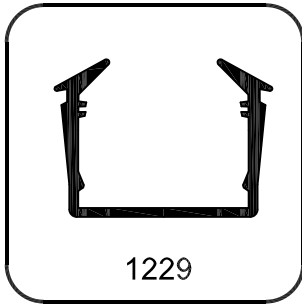
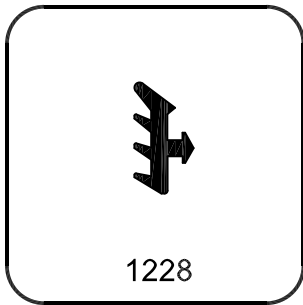
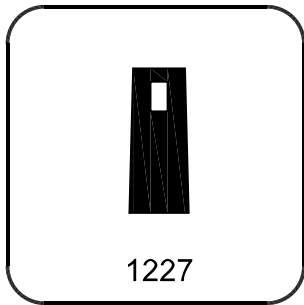
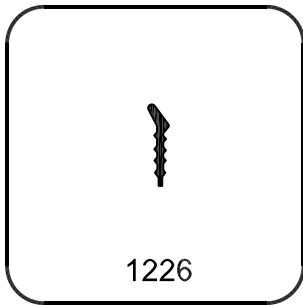
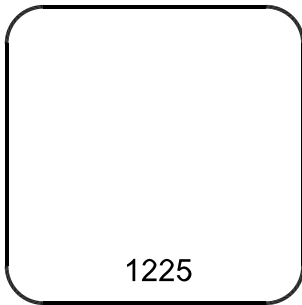
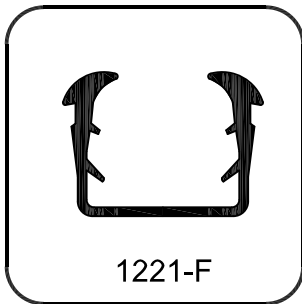
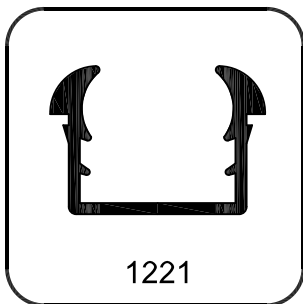
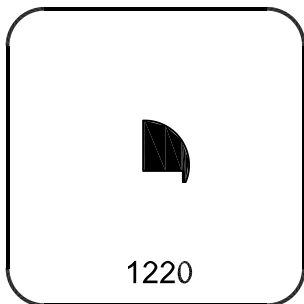
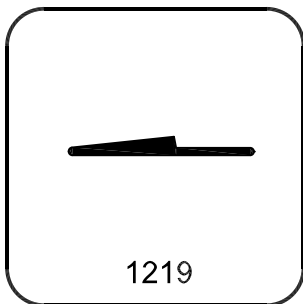
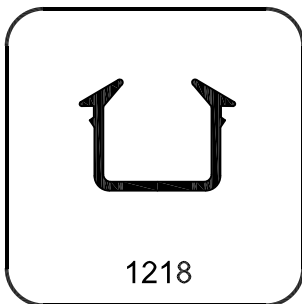

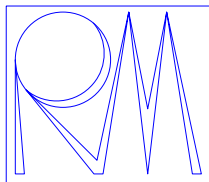
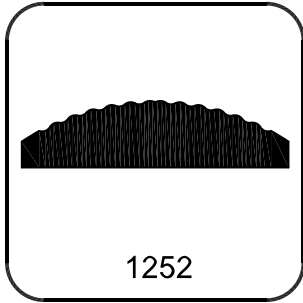
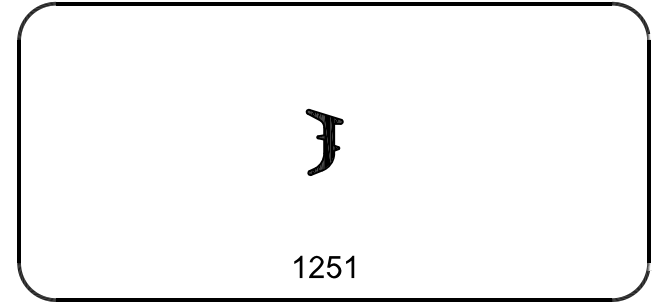
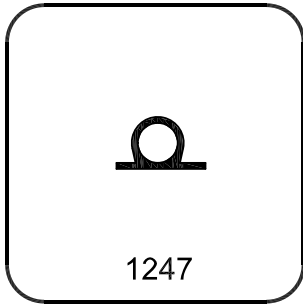
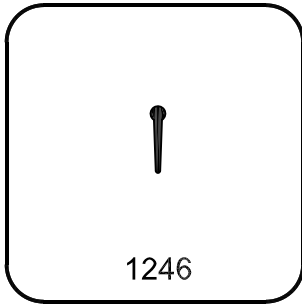
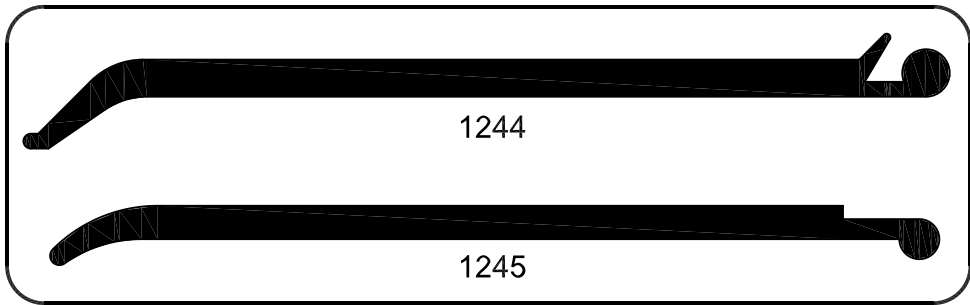
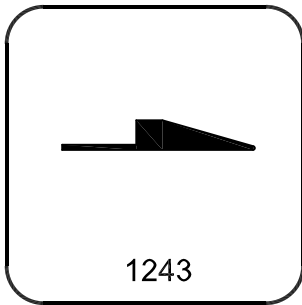
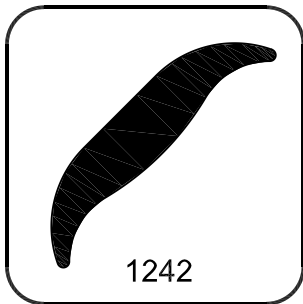
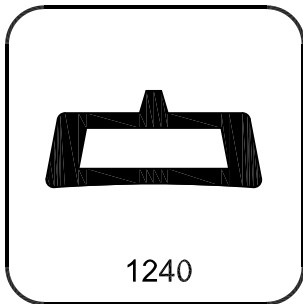
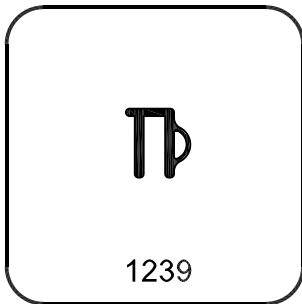
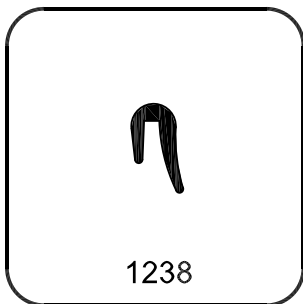
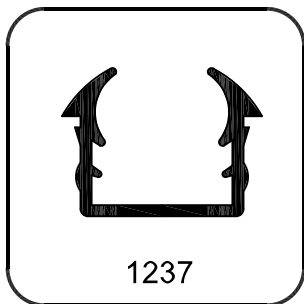
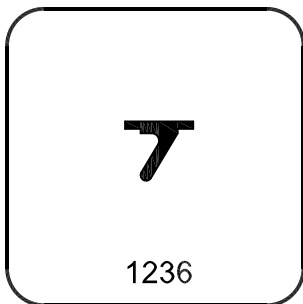
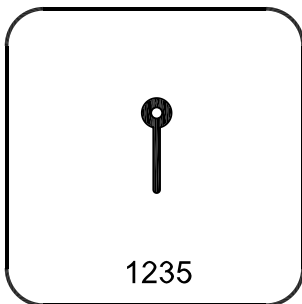

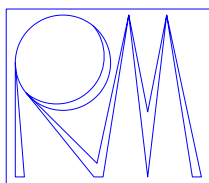
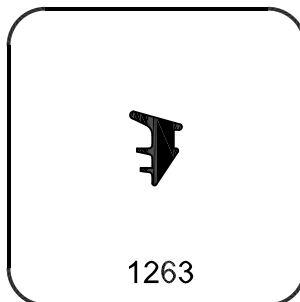
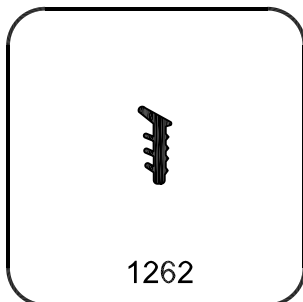
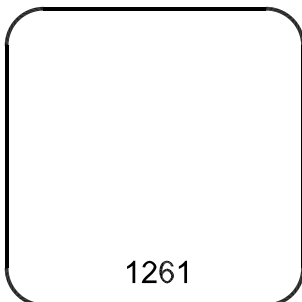
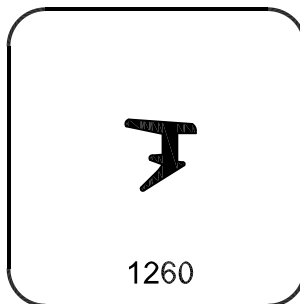
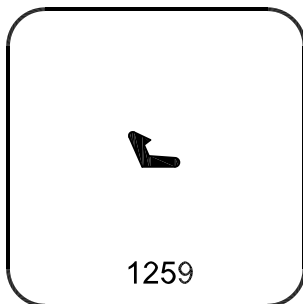
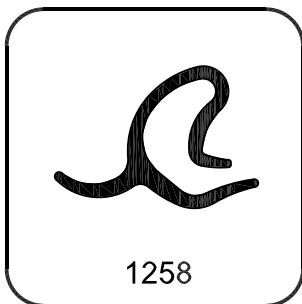
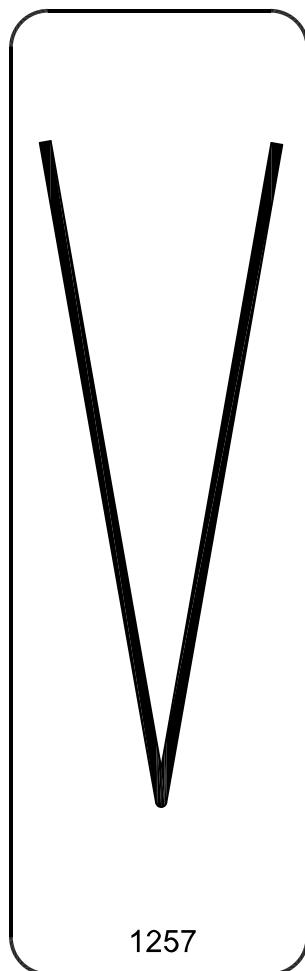
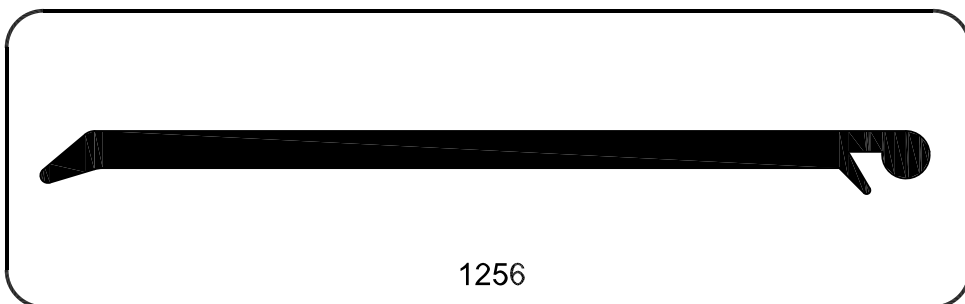
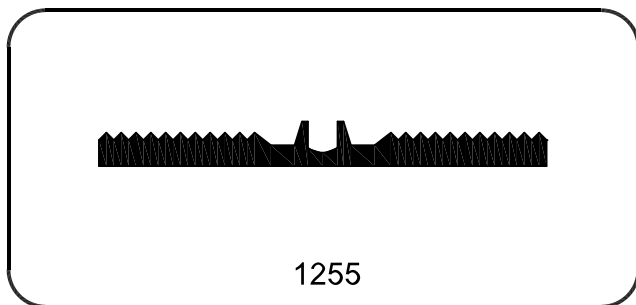
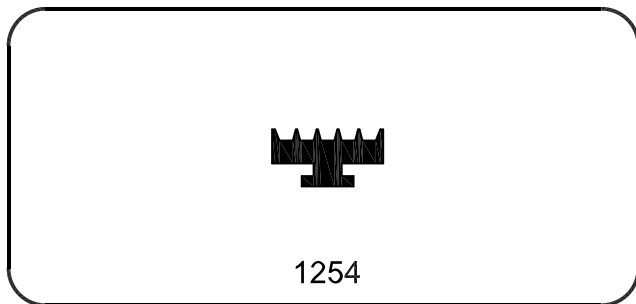
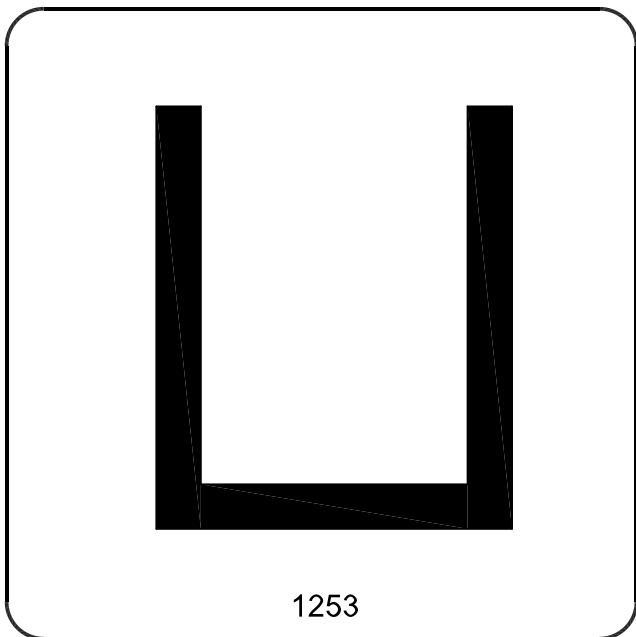

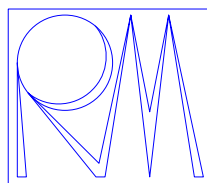
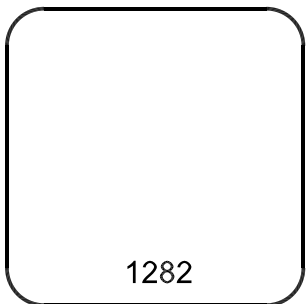
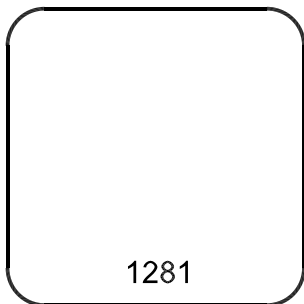
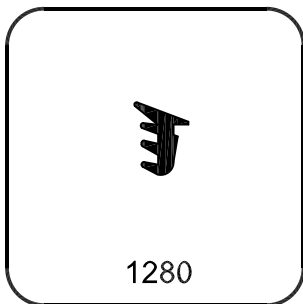
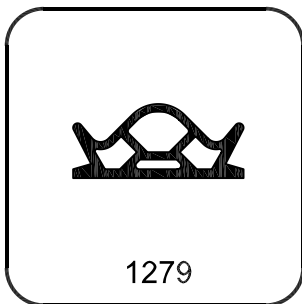
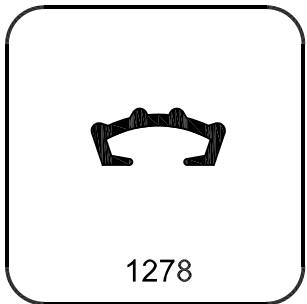
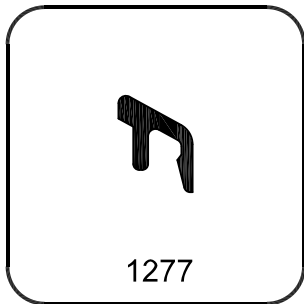
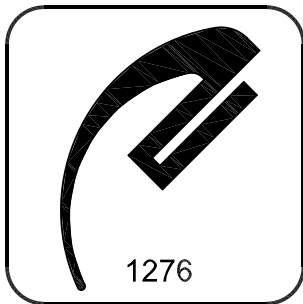
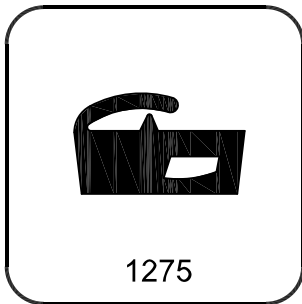
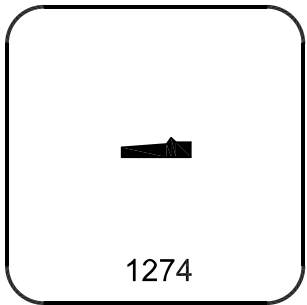
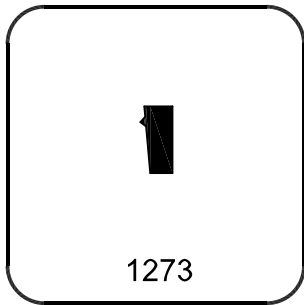
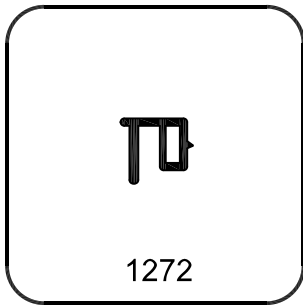
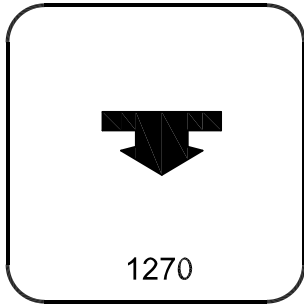
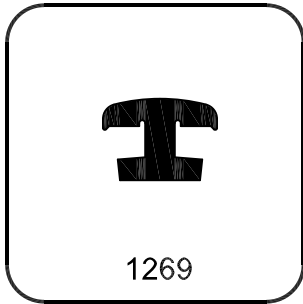
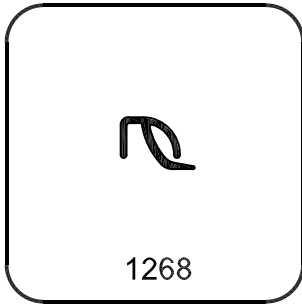
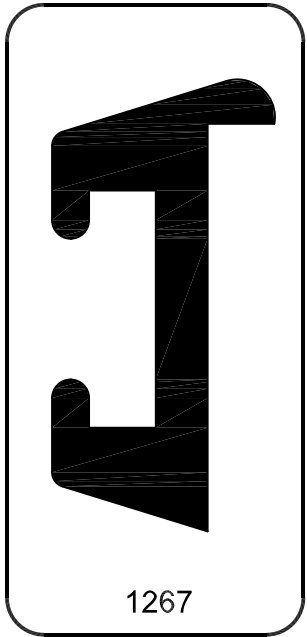
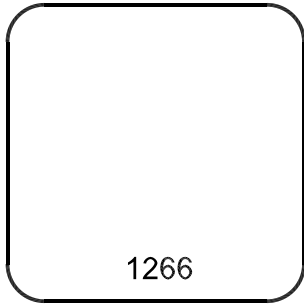
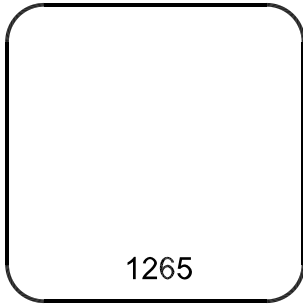
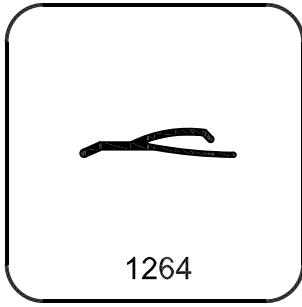

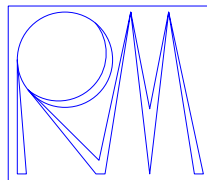
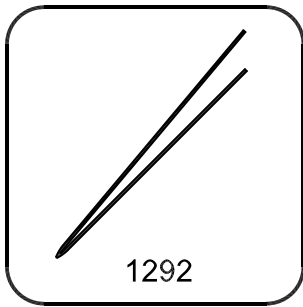
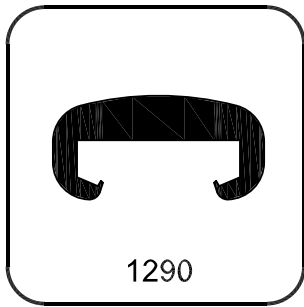
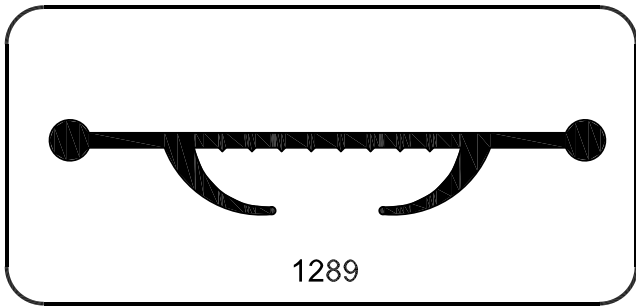
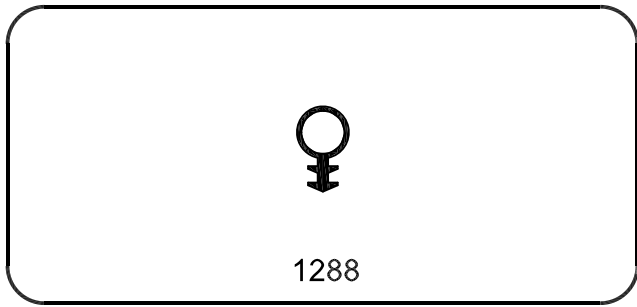
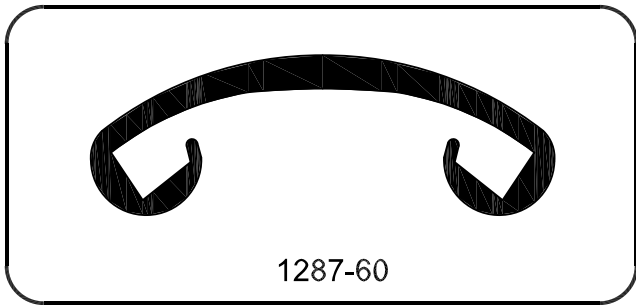
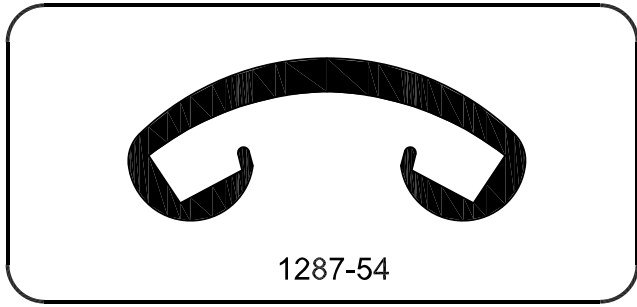
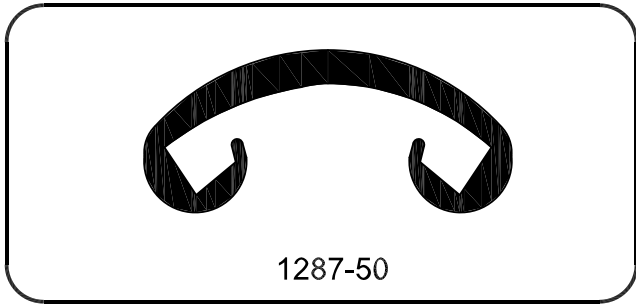
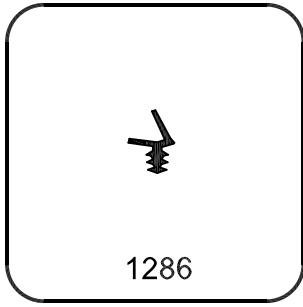
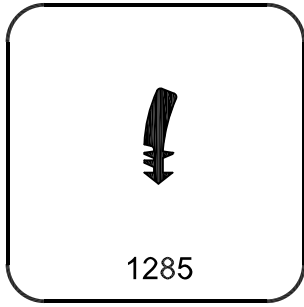
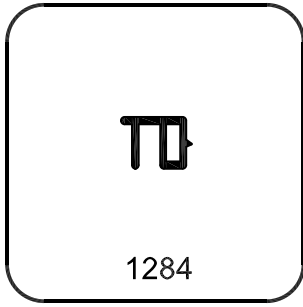
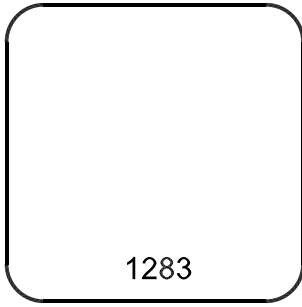

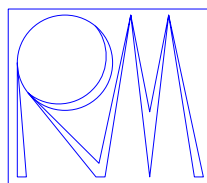
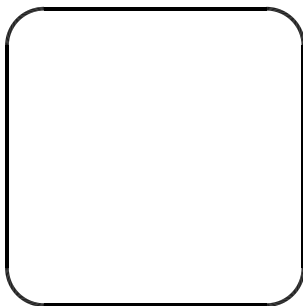
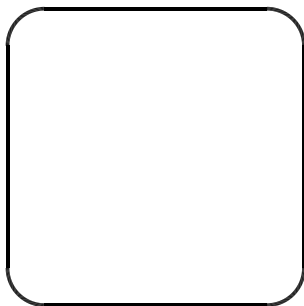
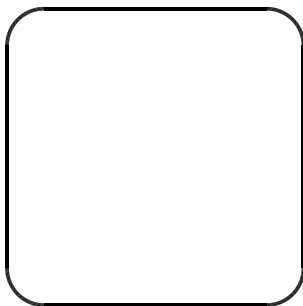
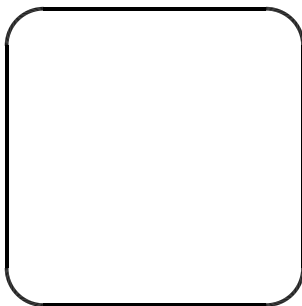
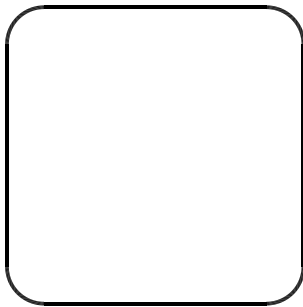
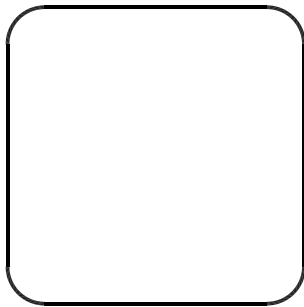
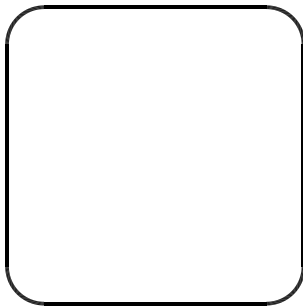
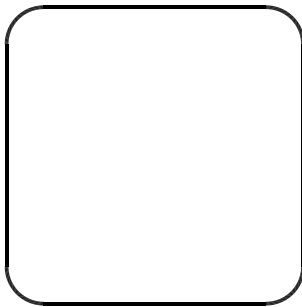
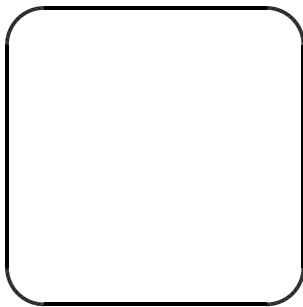
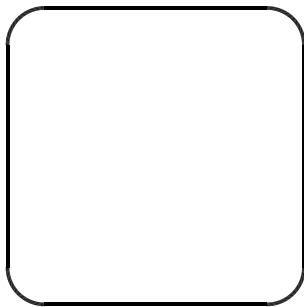
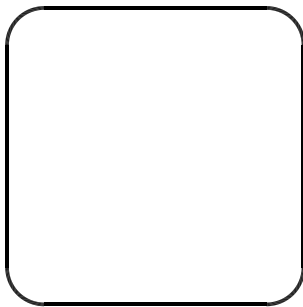
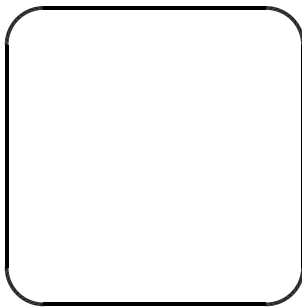
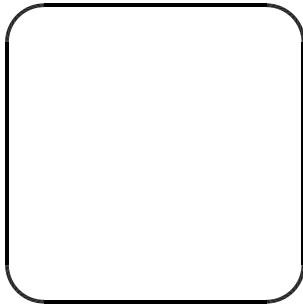
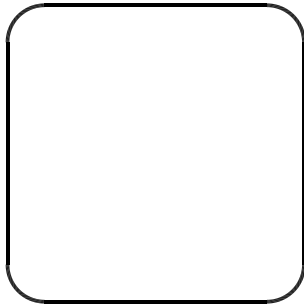
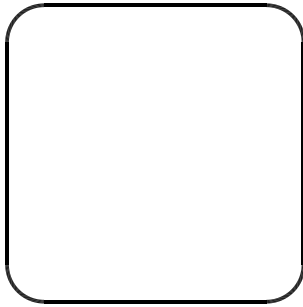
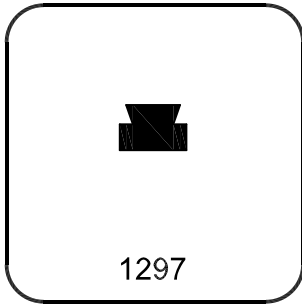
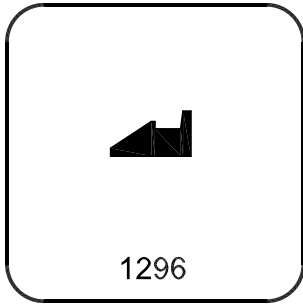
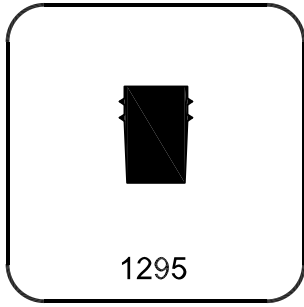
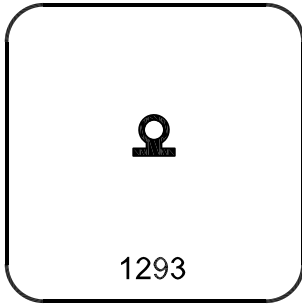

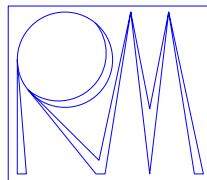
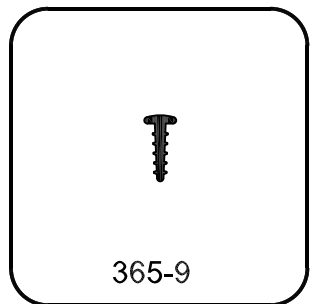
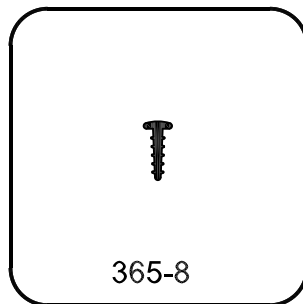
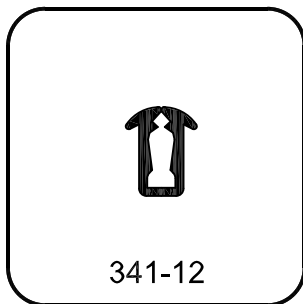
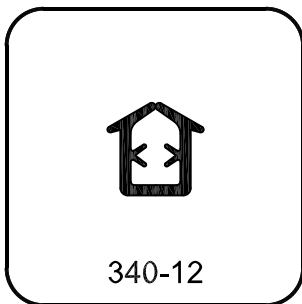
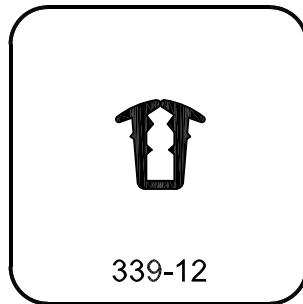
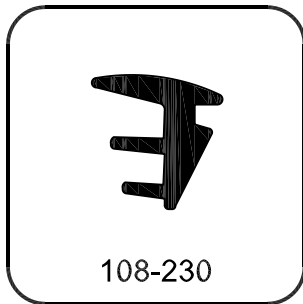
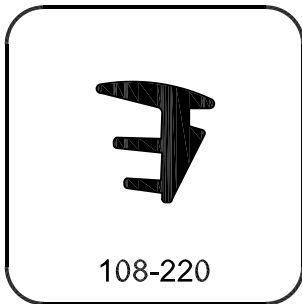
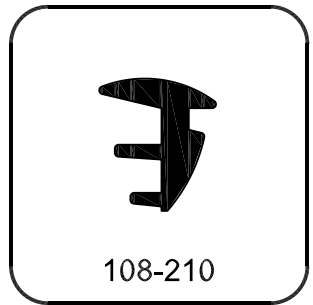
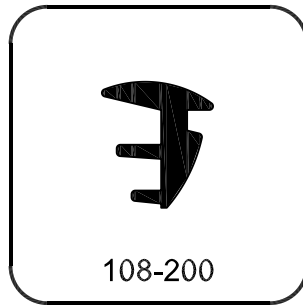
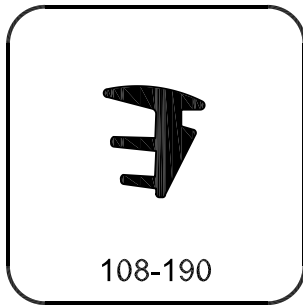
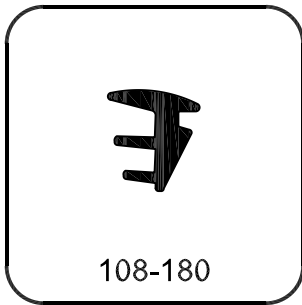
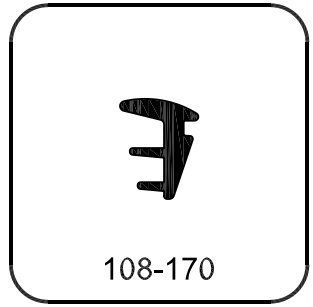
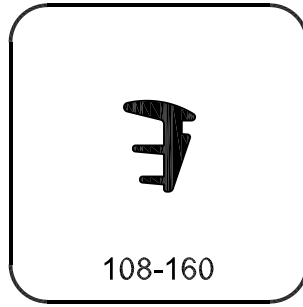
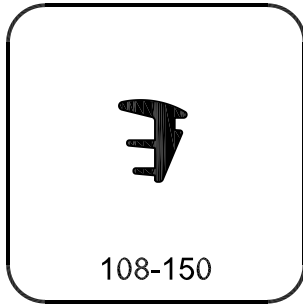
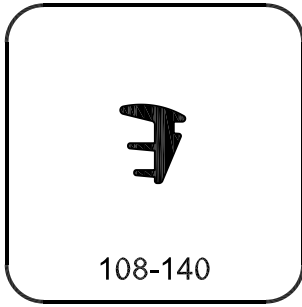
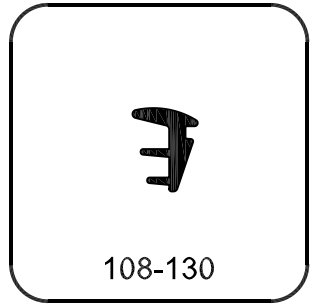
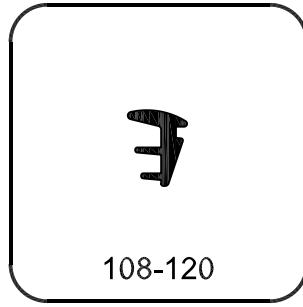
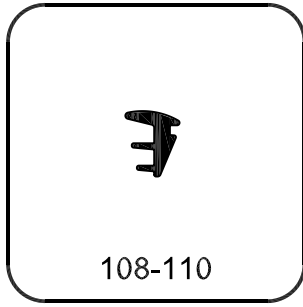
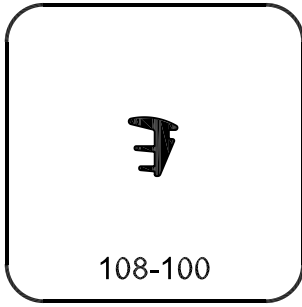

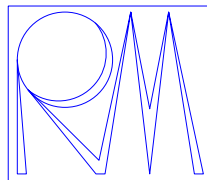
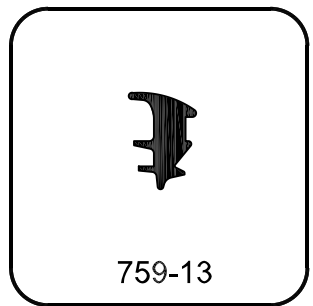
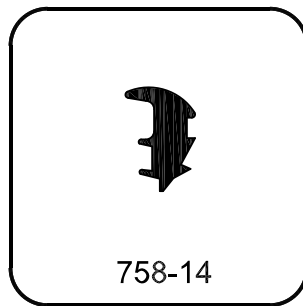
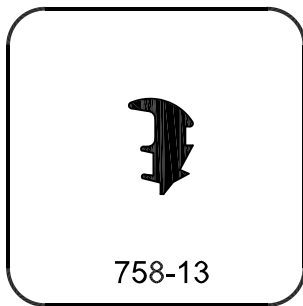
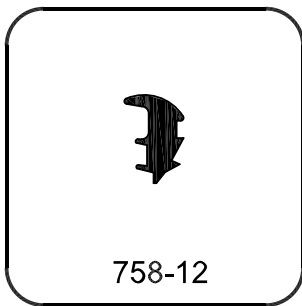
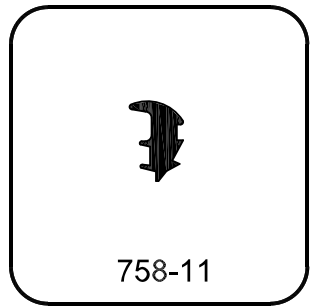
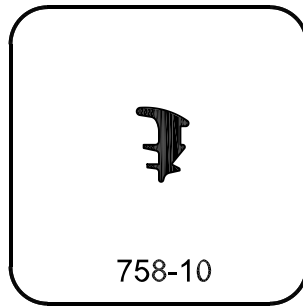
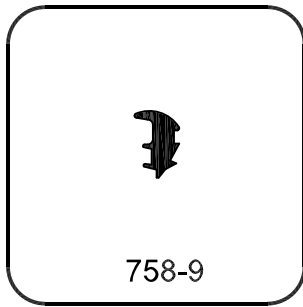
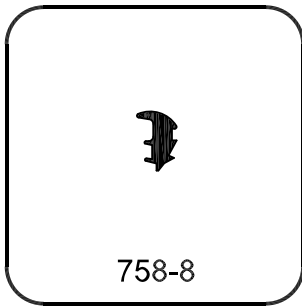
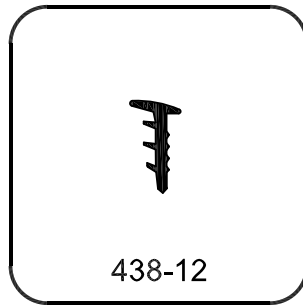
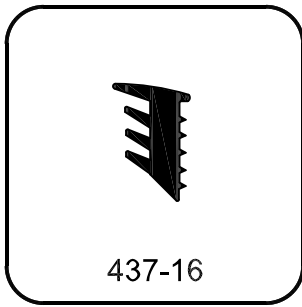
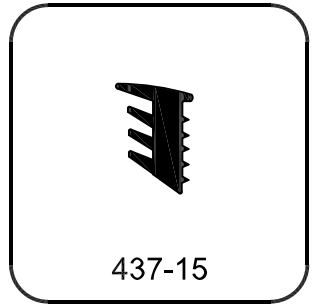
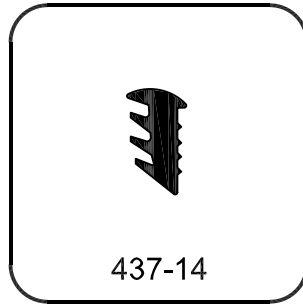
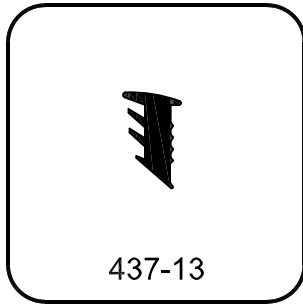
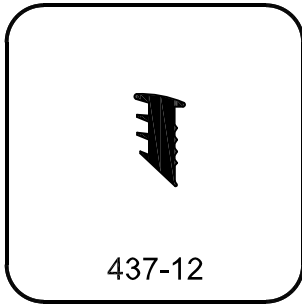
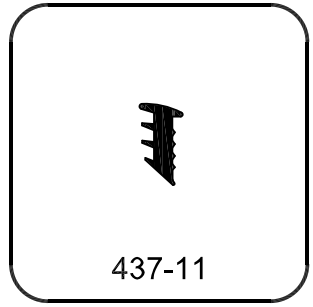
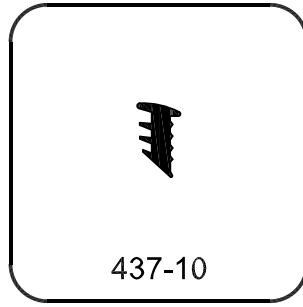
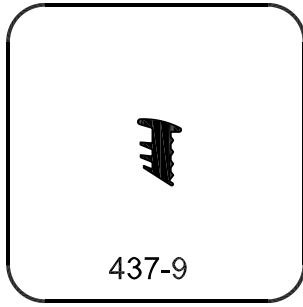
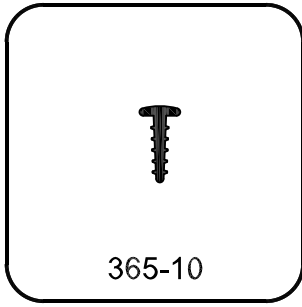

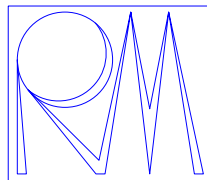
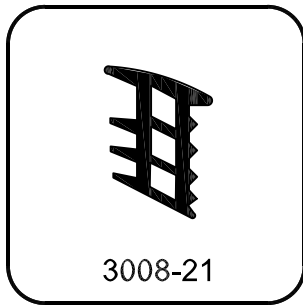
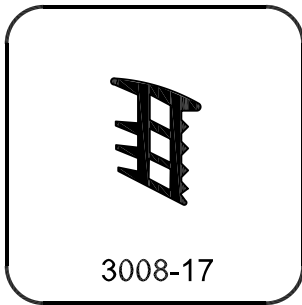
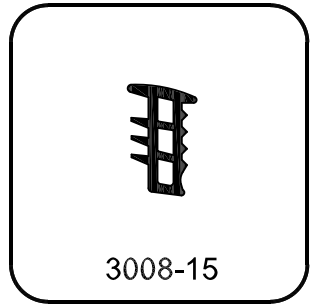
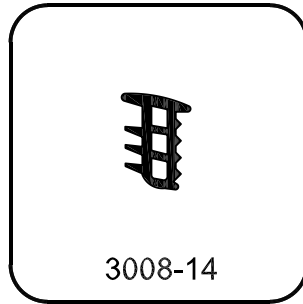
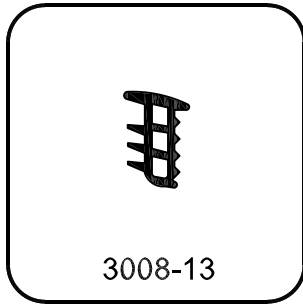
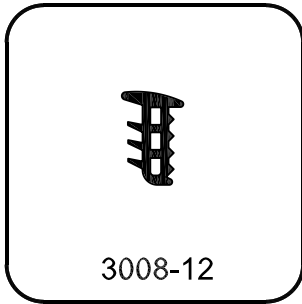
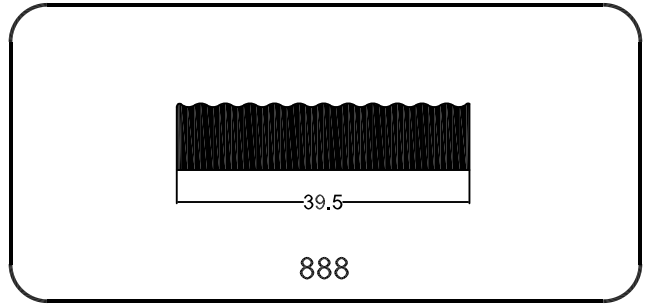
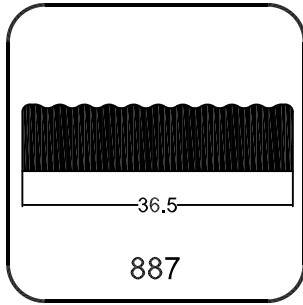
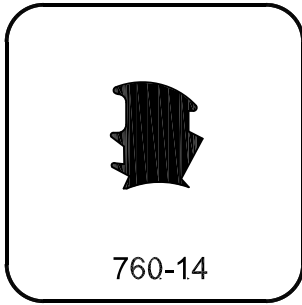

PVC Rígidos



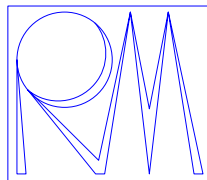
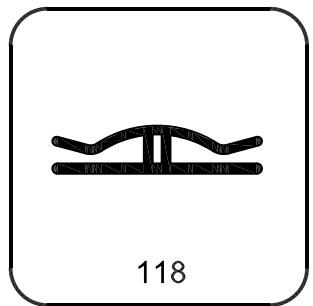
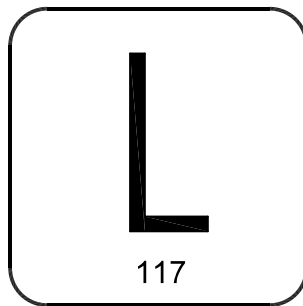
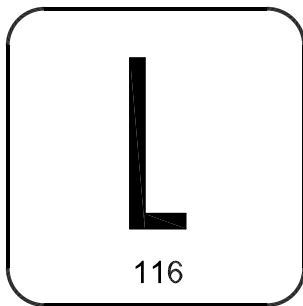
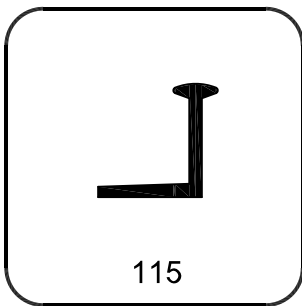
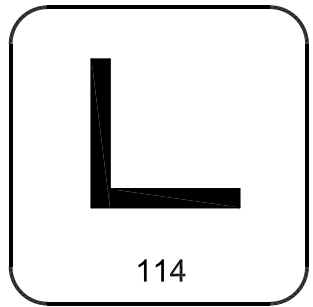
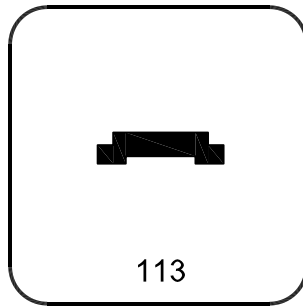
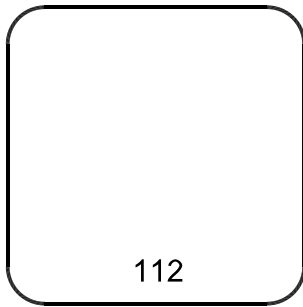
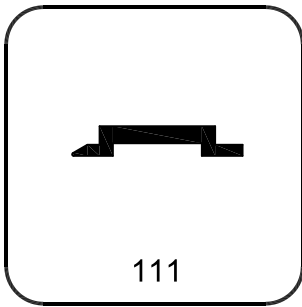
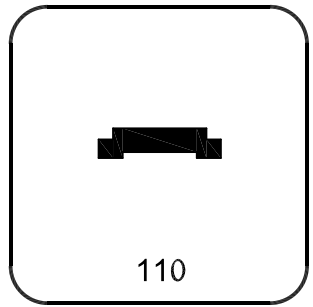
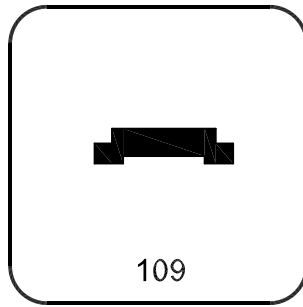
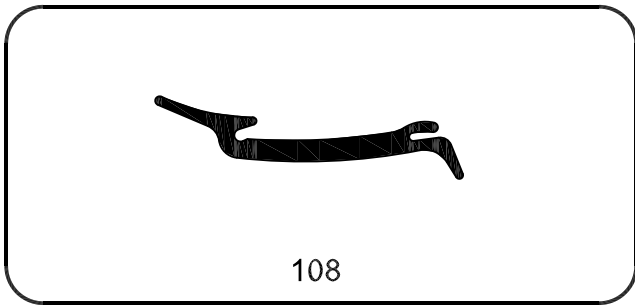
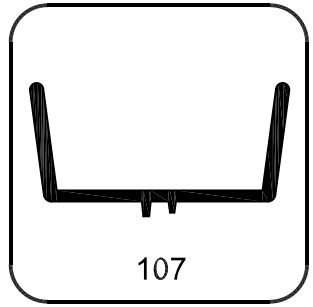
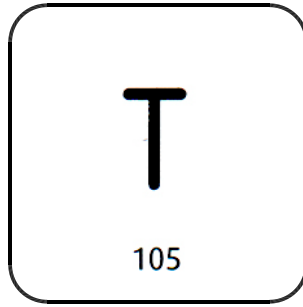
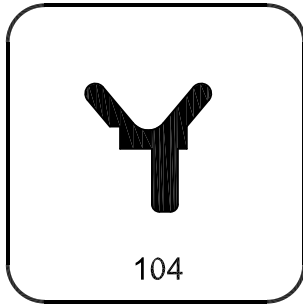
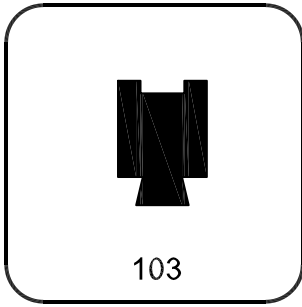
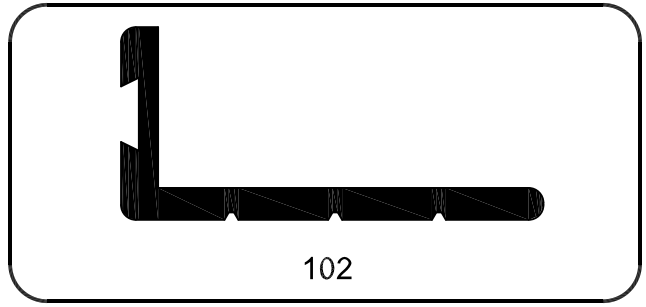
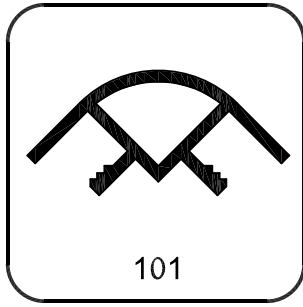
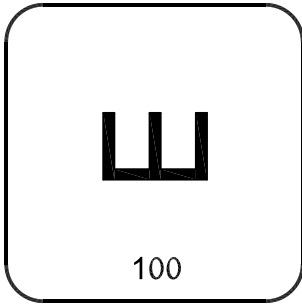

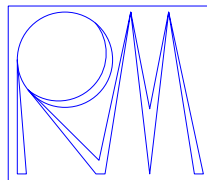
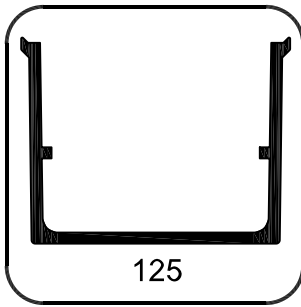
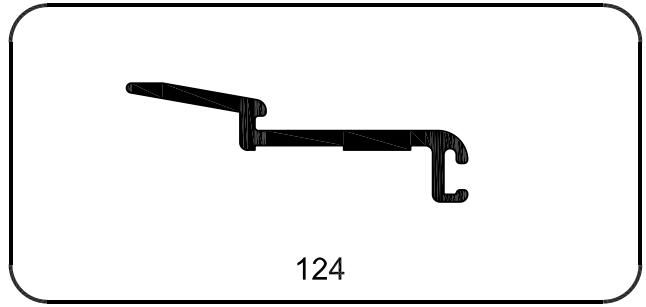
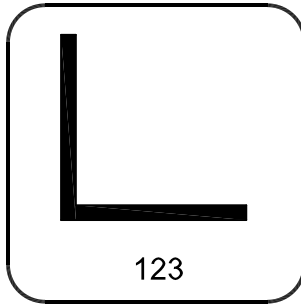
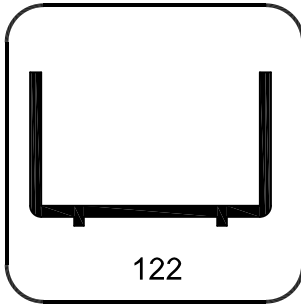
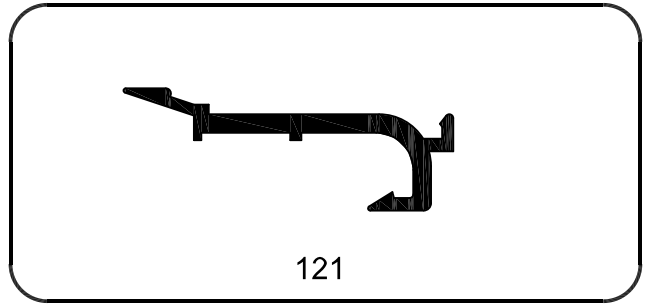
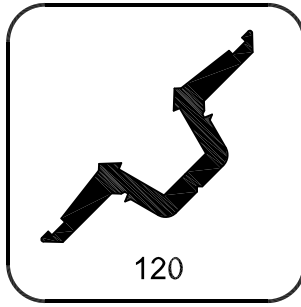
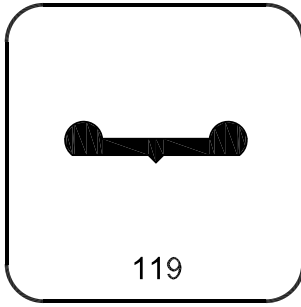

PVC 2 Durezas



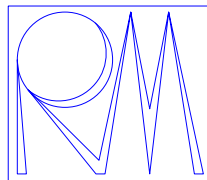
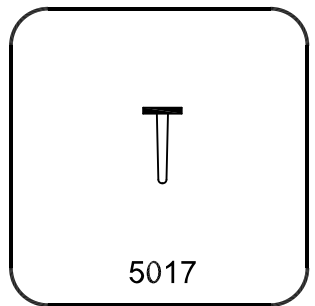
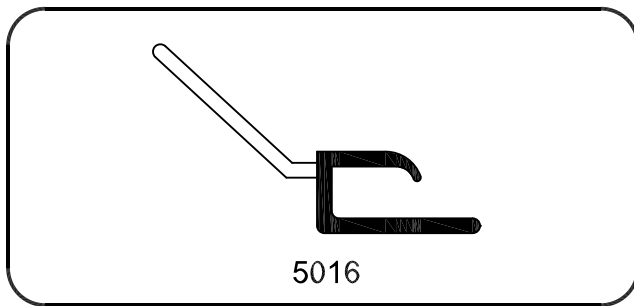
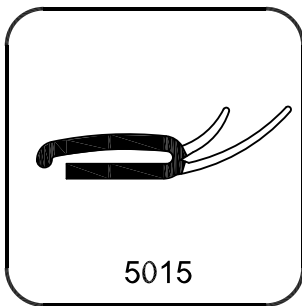
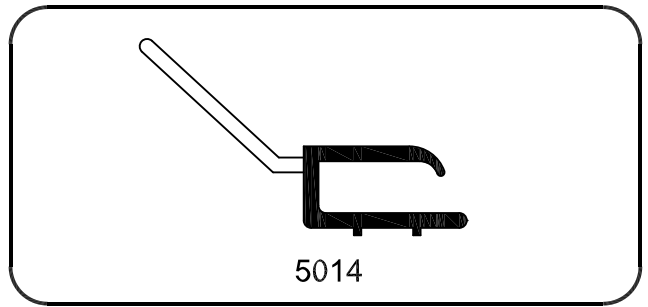
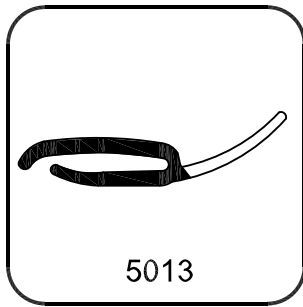
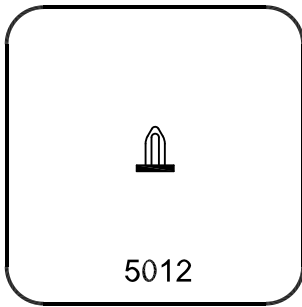
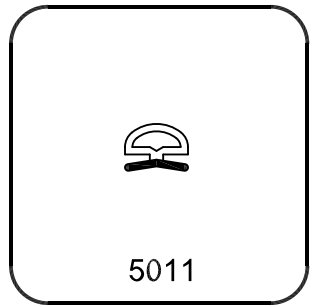
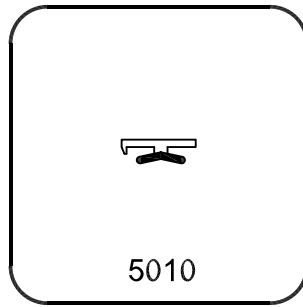
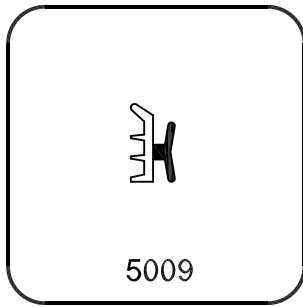
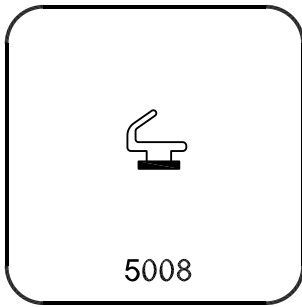
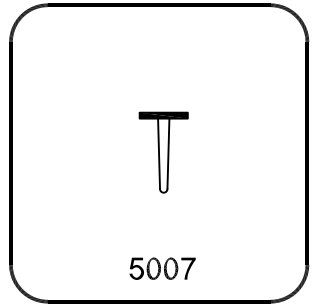
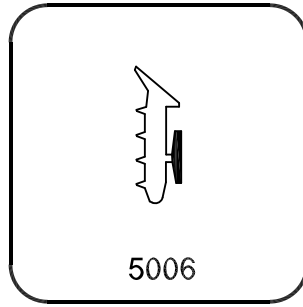
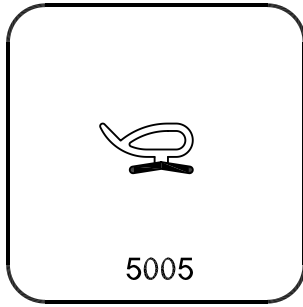
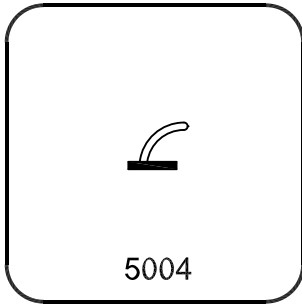
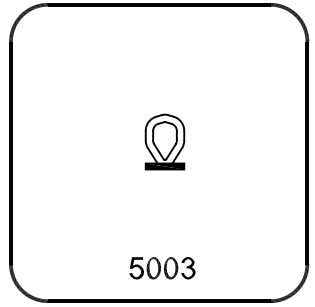
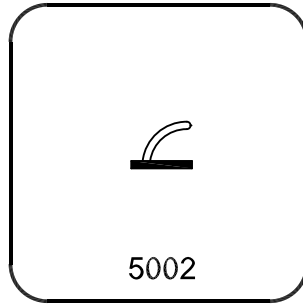
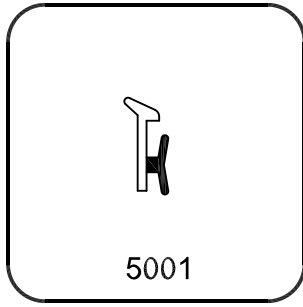
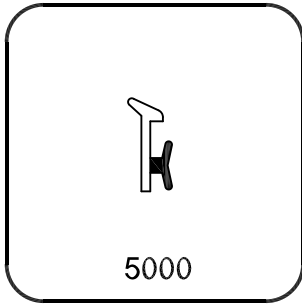

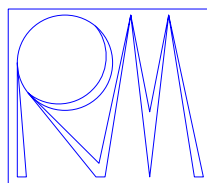
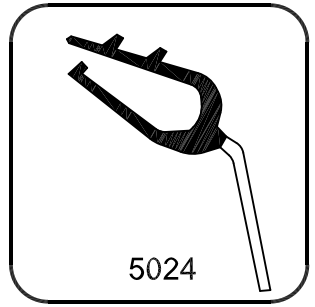
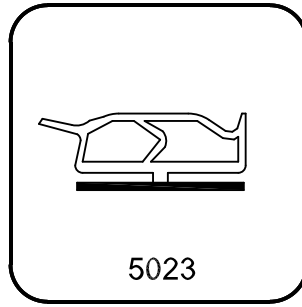
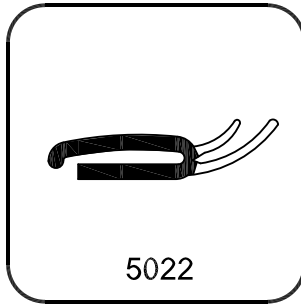
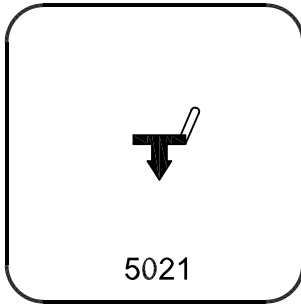
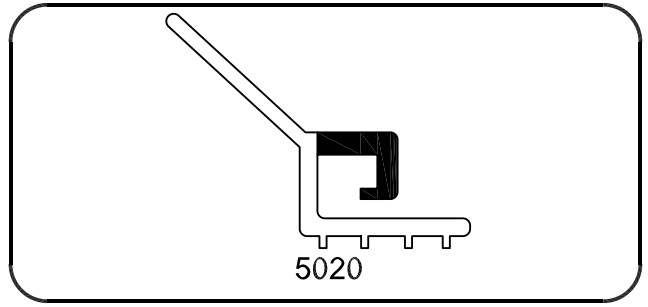
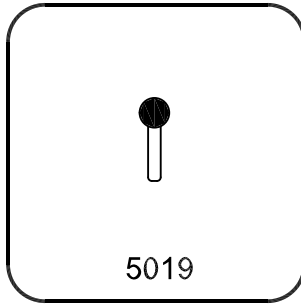
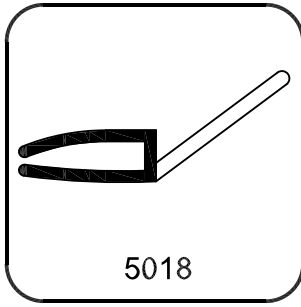

Pelucias



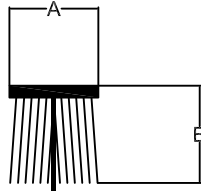

Pelucia COM Stop-Fin

A= 7 mm x B= 6 mm

A= 7 mm x B= 7 mm

A= 7 mm x B= 12 mm

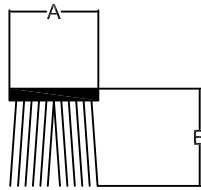

Pelucia SEM Stop-Fin

A= 4.5 mm x B= 7 mm

A= 6 mm x B= 5 mm

A= 6 mm x B= 7 mm

A= 6.5 mm x B= 4.5 mm

A= 6.5 mm x B= 5 mm

A= 6.5 mm x B= 5.5 mm

A= 6.5 mm x B= 6 mm

A= 7 mm x B= 4.5 mm

A= 7 mm x B= 5 mm

A= 7 mm x B= 5.5 mm

A= 7 mm x B= 6 mm

A= 7 mm x B= 6.5 mm

A= 7 mm x B= 7 mm

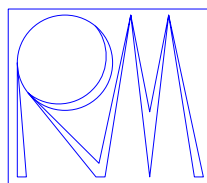

EPDM



